

415B Power Supply

Instruction Manual



WARRANTY

Notwithstanding any provision of any agreement the following warranty is exclusive:

The JOHN FLUKE MFG. CO., INC., warrants each instrument it manufactures to be free from defects in material and workmanship under normal use and service for the period of 1-year from date of purchase. This warranty extends only to the original purchaser. This warranty shall not apply to fuses, disposable batteries (rechargeable type batteries are warranted for 90-days), or any product or parts which have been subject to misuse, neglect, accident, or abnormal conditions of operations.

In the event of failure of a product covered by this warranty, John Fluke Mfg. Co., Inc., will repair and calibrate an instrument returned to an authorized Service Facility within 1 year of the original purchase; provided the warrantor's examination discloses to its satisfaction that the product was defective. The warrantor may, at its option, replace the product in lieu of repair. With regard to any instrument returned within 1 year of the original purchase, said repairs or replacement will be made without charge. If the failure has been caused by misuse, neglect, accident, or abnormal conditions of operations, repairs will be billed at a nominal cost. In such case, an estimate will be submitted before work is started, if requested.

THE FOREGOING WARRANTY IS IN LIEU OF ALL OTHER WARRANTIES, EXPRESS OR IMPLIED, INCLUDING BUT NOT LIMITED TO ANY IMPLIED WARRANTY OF MERCHANTABILITY, FITNESS, OR ADEQUACY FOR ANY PARTICULAR PURPOSE OR USE. JOHN FLUKE MFG. CO., INC., SHALL NOT BE LIABLE FOR ANY SPECIAL, INCIDENTAL, OR CONSEQUENTIAL DAMAGES, WHETHER IN CONTRACT, TORT, OR OTHERWISE.

If any failure occurs, the following steps should be taken:

1. Notify the JOHN FLUKE MFG. CO., INC., or nearest Service facility, giving full details of the difficulty, and include the model number, type number, and serial number. On receipt of this information, service data, or shipping instructions will be forwarded to you.
2. On receipt of the shipping instructions, forward the instrument, transportation prepaid. Repairs will be made at the Service Facility and the instrument returned, transportation prepaid.

SHIPPING TO MANUFACTURER FOR REPAIR OR ADJUSTMENT

All shipments of JOHN FLUKE MFG. CO., INC., instruments should be made via United Parcel Service or "Best Way" prepaid. The instrument should be shipped in the original packing carton; or if it is not available, use any suitable container that is rigid and of adequate size. If a substitute container is used, the instrument should be wrapped in paper and surrounded with at least four inches of excelsior or similar shock-absorbing material.

CLAIM FOR DAMAGE IN SHIPMENT TO ORIGINAL PURCHASER

The instrument should be thoroughly inspected immediately upon original delivery to purchaser. All material in the container should be checked against the enclosed packing list. The manufacturer will not be responsible for shortages against the packing sheet unless notified immediately. If the instrument is damaged in any way, a claim should be filed with the carrier immediately. (To obtain a quotation to repair shipment damage, contact the nearest Fluke Technical Center.) Final claim and negotiations with the carrier must be completed by the customer.

The JOHN FLUKE MFG. CO., INC., will be happy to answer all applications or use questions, which will enhance your use of this instrument. Please address your requests or correspondence to: JOHN FLUKE MFG. CO., INC., P.O. BOX C9090, EVERETT, WASHINGTON 98206, ATTN: Sales Dept. For European Customers: Fluke (Holland) B.V., P.O. Box 5053, 5004 EB, Tilburg, The Netherlands.

*For European customers, Air Freight prepaid.

John Fluke Mfg. Co., Inc., P.O. Box C9090, Everett, Washington 98206

Table of Contents

SECTION	TITLE	PAGE
1	INTRODUCTION AND SPECIFICATIONS	1-1
	1-1. Introduction	1-1
	1-2. General Description	1-1
	1-6. Electrical Specifications	1-1
	1-7. Mechanical Specifications	1-2
	1-8. Environmental Specifications	1-2
	1-9. Outline Drawing	1-2
2	OPERATING INSTRUCTIONS	2-1
	2-1. Receiving Inspection	2-1
	2-4. Controls, Terminals, and Indicators	2-1
	2-6. Power Input	2-1
	2-9. Initial Operation	2-1
	2-11. Operating Procedure	2-3
	2-12. Applications	2-4
3	THEORY OF OPERATION	3-1
	3-1. Introduction	3-1
	3-3. Block Diagram Analysis	3-1
	3-8. Circuit Descriptions	3-1
	3-25. Accuracy	3-2
4	MAINTENANCE	4-1
	4-1. Introduction	4-1
	4-3. Service Information	4-1
	4-6. General Maintenance	4-1
	4-15. Test Equipment Required for Maintenance	4-1

List of Illustrations

FIGURE	TITLE	PAGE
Frontispiece	Model 415B High Voltage Power Supply	iv
1-1	Model 415B Outline Drawing	1-2
2-1	Controls, Terminals and Indicators	2-2
2-2	Power Transformer Terminals	2-3
2-3	Operation with a Reference Divider	2-5
2-4	Leakage Current Testing	2-6
3-1	Model 415B Block Diagram	3-3
4-1	Test Equipment Required for Maintenance	4-2
4-2	Protection Circuit	4-3
4-3	Linearity Test: 500, 100, 10 Volt Steps	4-4
4-4	Ripple on 125 Volt Supply	4-6
4-5	Ripple on High Voltage DC Output	4-8
5-1	High Voltage Power Supply	5-4
5-2	Chassis Assembly	5-6
5-3	Front Panel Assembly	5-7
5-4	Switch P/C Assembly	5-9
5-5	High Voltage Rectifier P/C Assembly	5-12
5-6	Series Pass P/C Assembly	5-14
5-7	Amplifier P/C Assembly	5-17
5-8	Bleeder P/C Assembly	5-19

TABLES OF CONTENTS, *continued*

SECTION	TITLE	PAGE
4-17.	Performance Tests	4-2
4-29.	Calibration	4-4
4-35.	Troubleshooting	4-5
5	LIST OF REPLACEABLE PARTS	5-1
5-1.	Introduction	5-1
5-3.	Columnar Information	5-1
5-4.	How to Obtain Parts	5-1
5-7.	Serial Number Effectivity	5-2
	 APPENDIX A – FEDERAL SUPPLY CODE FOR MANUFACTURERS	
	 APPENDIX B – LIST OF ABBREVIATIONS	
	 APPENDIX C – SALES REPRESENTATIVES AND SERVICE CENTERS	
	 SCHEMATIC DIAGRAMS	

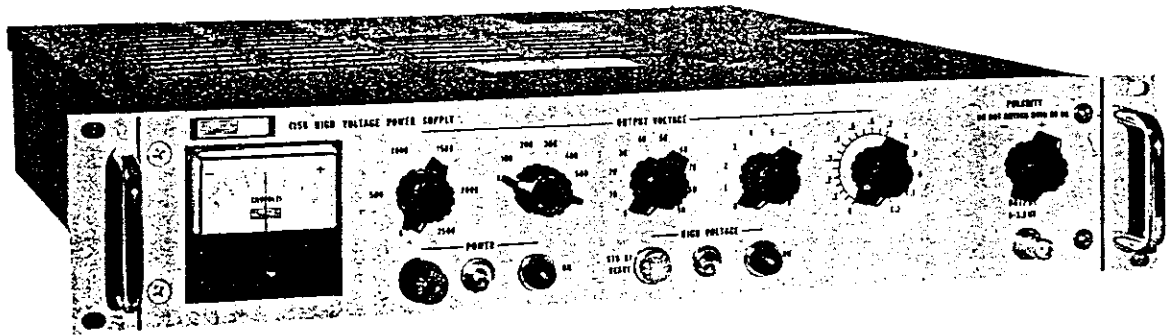

MODEL 415B HIGH VOLTAGE POWER SUPPLY

Section 1

Introduction & Specifications

1-1. INTRODUCTION**1-2. General Description**

1-3. The Model 415B High Voltage Power Supply is a stable well regulated source of dc voltage. The Model 415B is capable of providing 0 to 3100 volts dc and 0 to 30 milliamperes current. The output voltage is adjustable in steps of 500, 100, 10 and 1 volt by front panel step switch controls. A vernier control provides a means of fine adjustment within the one volt steps. Output power is available from both a front and rear panel high voltage connector, type UG931/U. Output voltage polarity may be switched by a front panel control to provide either a positive or negative output with respect to chassis ground of the instrument.

1-4. The power supply is provided with an overcurrent protection circuit to prevent damage to the instrument in the event of overload or accidental short circuit at the output. Normal operation is quickly restored by a manual reset control following removal of the overload.

1-5. The Model 415B combines the best features of electron tubes and solid state components in a hybrid circuit. The improved reliability and temperature stability characteristics of silicon transistor amplifiers and rectifier diodes together with the high voltage handling characteristics of vacuum tubes provide a dependable, low noise level, highly regulated output. Applications of the Model 415B include calibration of voltmeters and powering of photomultiplier tubes, high voltage klystrons or other devices with current requirements up to 30 milliamperes.

1-6. ELECTRICAL SPECIFICATIONS**OUTPUT VOLTAGE**

Adjustable from 0 to ± 3100 volts dc.

OUTPUT CURRENT

0 to 30 milliamperes.

OUTPUT POLARITY

Positive or negative with respect to ground (the polarity is controlled by a front panel switch).

LOAD REGULATION

0.0005% or 5 millivolts (whichever is greater) from a no load to a full load change in output current.

LINE REGULATION

0.0005% or 2 millivolts (whichever is greater) for a 10% line change from nominal.

STABILITY

$\pm 0.0020\%$ per hour; $\pm 0.01\%$ per day after warmup period and constant line voltage, constant load and constant temperature.

RIPPLE

Less than 100 microvolts RMS; less than 1 millivolt peak-to-peak.

RESOLUTION

5 millivolts.

CALIBRATION ACCURACY

$\pm 0.25\%$ or 100 millivolts (whichever is greater) with vernier at zero.

RESETABILITY

$\pm 0.05\%$ or 50 millivolts.

RECOVERY TIME

Within 50 microseconds.

OVERCURRENT PROTECTION

Adjusted to disconnect output at nominally 30 milliamperes $\pm 10\%$ load current. Manual reset.

WARMUP TIME

60 minutes to meet specifications.

INPUT POWER

100/115/230 volts ac $\pm 10\%$, 50 to 60 Hz, approximately 300 volt-amperes at full load output.

1-7. MECHANICAL SPECIFICATIONS

OUTPUT CONNECTORS

One UG931/U front and rear (one mating connector supplied).

METER

3100-0-3100 vdc ($\pm 3\%$).

WEIGHT

Approximately 30 pounds.

1-8. ENVIRONMENTAL SPECIFICATIONS

OPERATING TEMPERATURE

0° C to 50° C.

STORAGE TEMPERATURE

-20° C to 70° C.

HUMIDITY

0 to 80%.

ALTITUDE OF OPERATION

Sea level to 10,000 feet.

STORAGE OR SHIPPING ALTITUDE

Sea level to 50,000 feet.

VIBRATION

Meets MIL-T-945A.

SHOCK

Meets MIL-E-4970A (20 g's, 11 milliseconds in three principal axes).

TEMPERATURE COEFFICIENT OF OUTPUT

Less than 20 ppm per ° C from +10° C to -40° C.

1-9. OUTLINE DRAWING

1-10. Figure 1-1 is an outline drawing showing all dimensions necessary for mounting and installation.

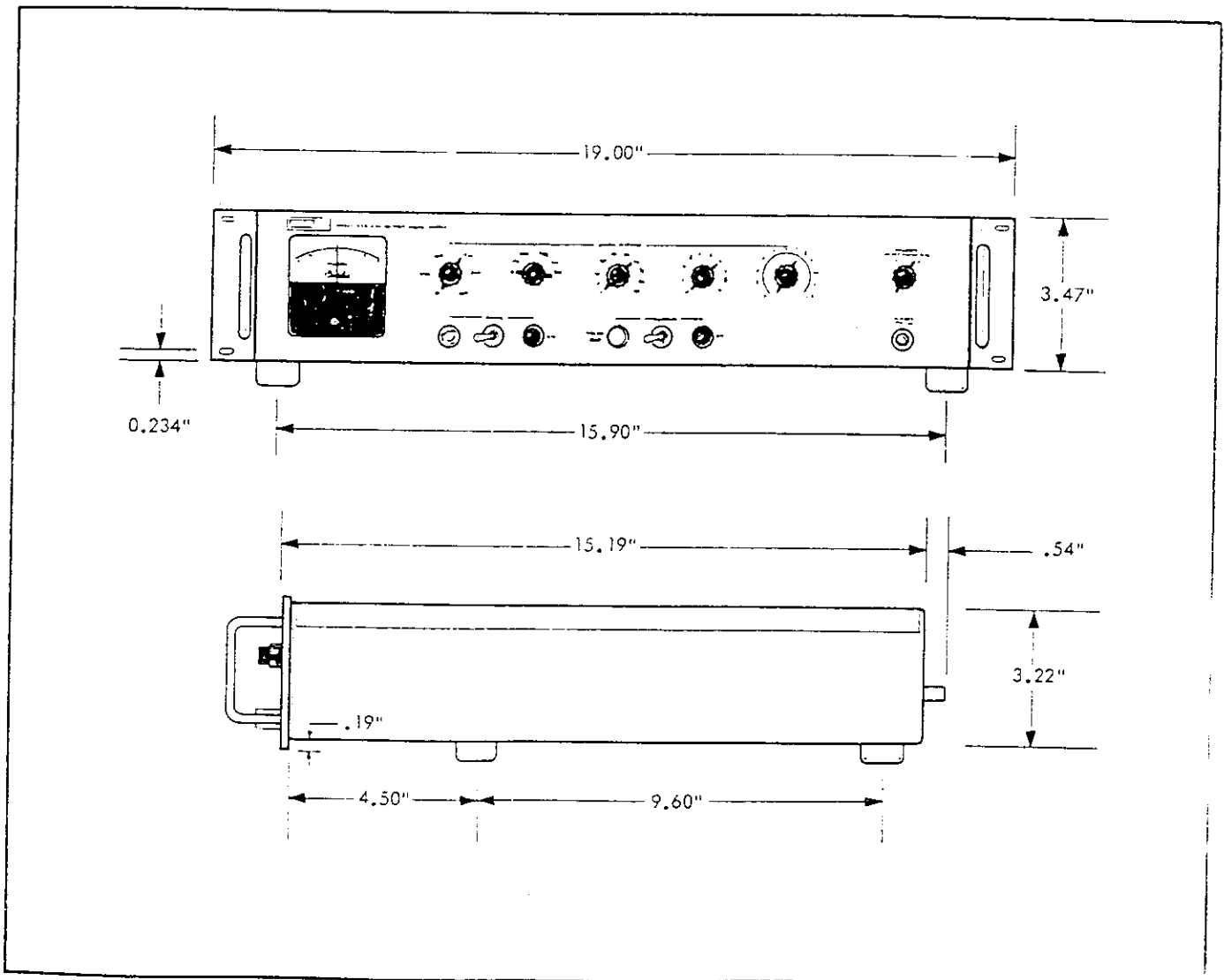

Figure 1-1. MODEL 415B OUTLINE DRAWING



static awareness



A Message From
John Fluke Mfg. Co., Inc.

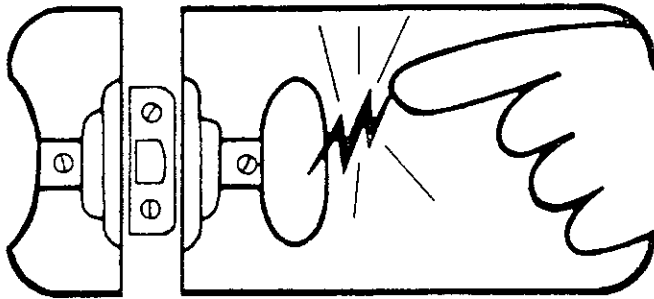

Some semiconductors and custom IC's can be damaged by electrostatic discharge during handling. This notice explains how you can minimize the chances of destroying such devices by:

1. Knowing that there is a problem.
2. Learning the guidelines for handling them.
3. Using the procedures, and packaging and bench techniques that are recommended.

The Static Sensitive (S.S.) devices are identified in the Fluke technical manual parts list with the symbol



The following practices should be followed to minimize damage to S.S. devices.

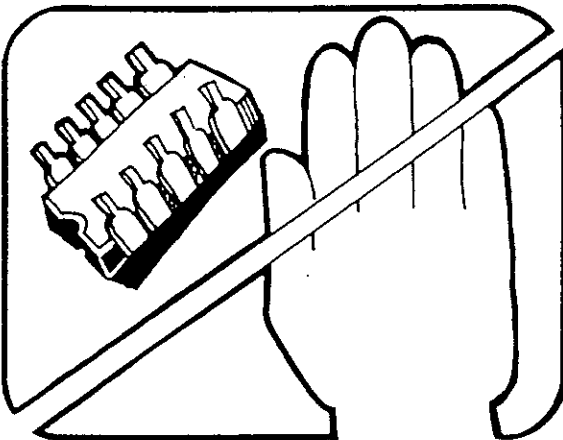

1. MINIMIZE HANDLING

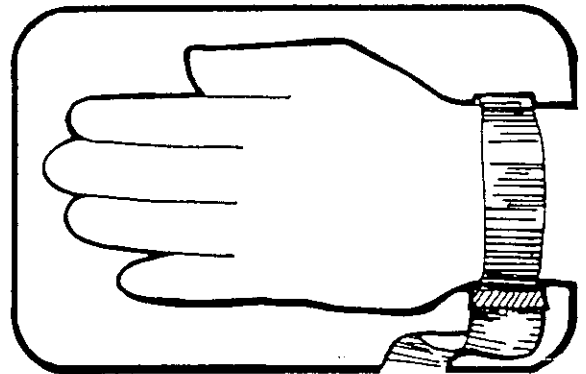

3. DISCHARGE PERSONAL STATIC BEFORE HANDLING DEVICES

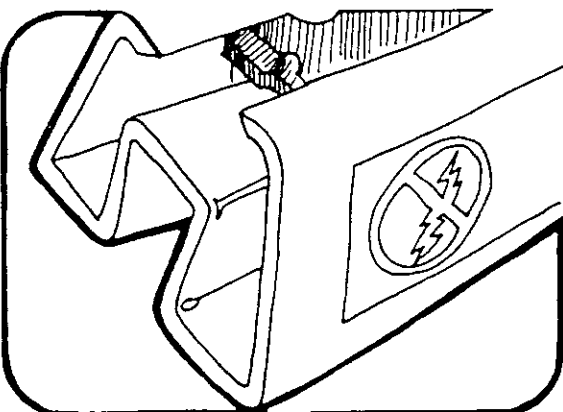

2. KEEP PARTS IN ORIGINAL CONTAINERS UNTIL READY FOR USE.

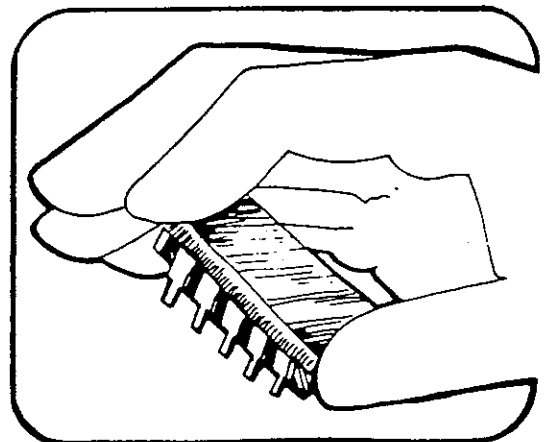

4. HANDLE S.S. DEVICES BY THE BODY

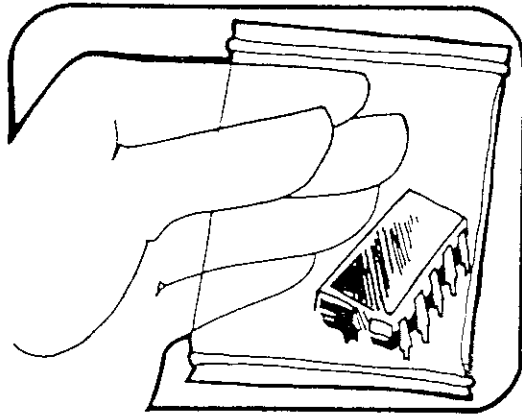

5. USE ANTI-STATIC CONTAINERS FOR HANDLING AND TRANSPORT

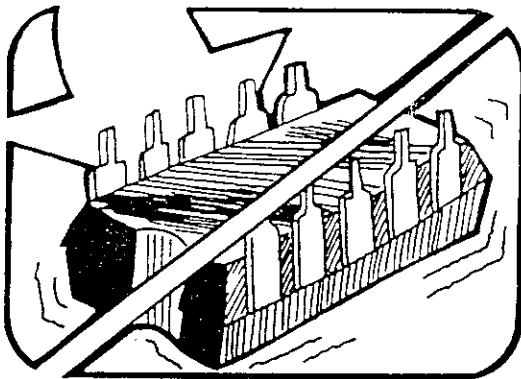

6. DO NOT SLIDE S.S. DEVICES OVER ANY SURFACE

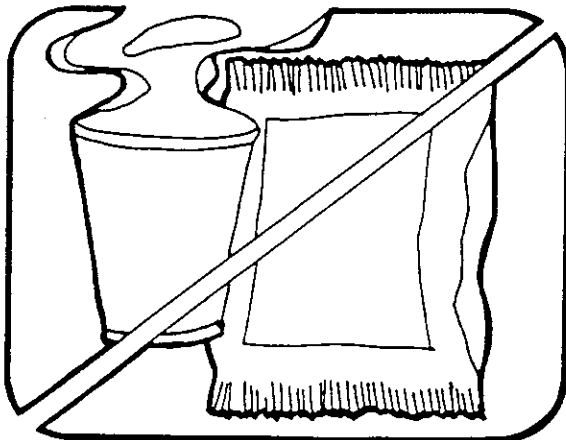

7. AVOID PLASTIC, VINYL AND STYROFOAM® IN WORK AREA

PORTIONS REPRINTED
WITH PERMISSION FROM TEKTRONIX, INC.
AND GENERAL DYNAMICS, POMONA DIV.

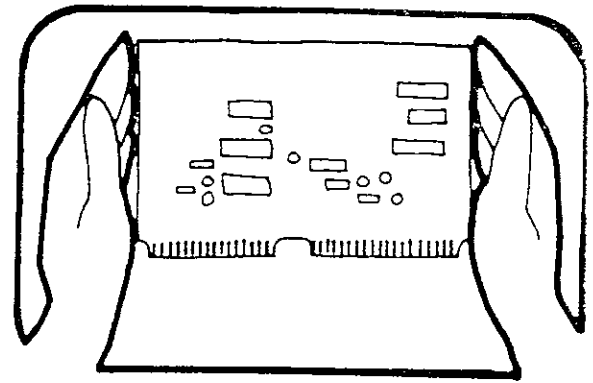

8. WHEN REMOVING PLUG-IN ASSEMBLIES, HANDLE ONLY BY NON-CONDUCTIVE EDGES AND NEVER TOUCH OPEN EDGE CONNECTOR EXCEPT AT STATIC-FREE WORK STATION. PLACING SHORTING STRIPS ON EDGE CONNECTOR USUALLY PROVIDES COMPLETE PROTECTION TO INSTALLED SS DEVICES.

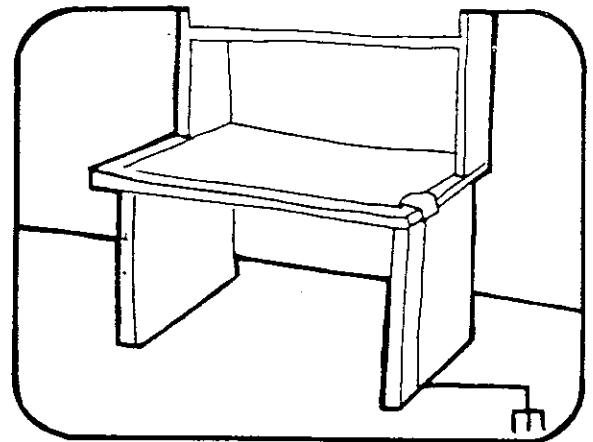

9. HANDLE S.S. DEVICES ONLY AT A STATIC-FREE WORK STATION
10. ONLY ANTI-STATIC TYPE SOLDER-SUCKERS SHOULD BE USED.
11. ONLY GROUNDED TIP SOLDERING IRONS SHOULD BE USED.

Anti-static bags, for storing S.S. devices or pct with these devices on them, can be ordered from the John Fluke Mfg. Co., Inc.. See section 5 in any FLU technical manual for ordering instructions. Use the following part numbers when ordering these special bags.

John Fluke Part No.	Description
680892	5" x 8" Bag
680934	8" x 10" Bag
680942	8" x 12" Bag
680983	12" x 16" Bag
681023	18" x 18" Bag

Pink Poly Sheet	Wrist Strap
30" x 60" x 60 Mil	P/N TL6-60
P/N RC-AS-1200	\$7.00
\$20.00	

Section 2

Operating Instructions

2-1. RECEIVING INSPECTION

2-2. This instrument has been thoroughly tested and inspected before being shipped from the factory. Immediately upon receiving the instrument, carefully inspect for damage which may have occurred during shipment. If any damage is noted, follow the instructions outlined in the back of this manual.

2-3. Should any difficulties be encountered during operation of your instrument, please feel free to contact your nearest John Fluke sales representative or write directly to the John Fluke Mfg. Co., Inc. with a statement of the problem.

2-4. CONTROLS, TERMINALS, AND INDICATORS

2-5. The location and function of the front panel controls is shown in Figure 2-1.

2-6. POWER INPUT

2-7. Two power transformers (T1) are available for this instrument, 100/115 vac or 115/230 vac. On the rear panel of each instrument a decal indicates the operating voltage can be changed by altering the wiring configuration of the transformer. To change the operating voltage of the 115/230 vac transformer, refer to paragraph 2-8. Refer to Figure 2-2 for changing the operating voltage of the 100/115 vac power transformer. To gain access to the power transformer, remove the instrument's top cover. The power required to operate the instrument is approximately 300 volt amperes at full-load output.

2-8. Should it be necessary to convert the instrument from 115 to 230 volt operation, proceed as follows. Electrical changes are shown on the decal on the underside of the top cover and on the schematic in the back of this manual.

- a. Remove the jumpers between 1 and 2 and between 3 and 4.

- b. Connect a jumper between terminals 2 and 3.
- c. Change the fuse from a 3 ampere slow-blow to a 1.5 ampere slow-blow.

2-9. INITIAL OPERATION

2-10. The following procedure is recommended when operating the Model 415B for the first time after shipping or a long period of idleness. This procedure will minimize the possibility of damage resulting from a faulty component.

- a. Connect the line plug to a 115 volts ac power source. If the instrument has been wired for 230 volt operation, connect to 230 volts ac.

WARNING!

This instrument is equipped with a 3-wire line cord, one lead of which is connected to the metal chassis. Connection to a properly-wired outlet automatically connects the chassis of the instrument to earth ground. If an adapter is used to connect the line to a two-contact outlet, the green lead extending from the adapter should be connected to a suitable ground.

- b. Set the HIGH VOLTAGE switch to STDBY/RESET.
- c. Set the POWER switch to ON. The ON lamp will illuminate. After approximately 30 seconds, the time-delay relay will close and the STDBY/RESET lamp will illuminate.
- d. Set the second OUTPUT VOLTAGE dial to 500.
- e. After the STDBY/RESET lamp illuminates, set the HIGH VOLTAGE switch to ON. Carefully observe if the HIGH VOLTAGE ON lamp illuminates and if the panel meter indicates 500 (± 15) volts.

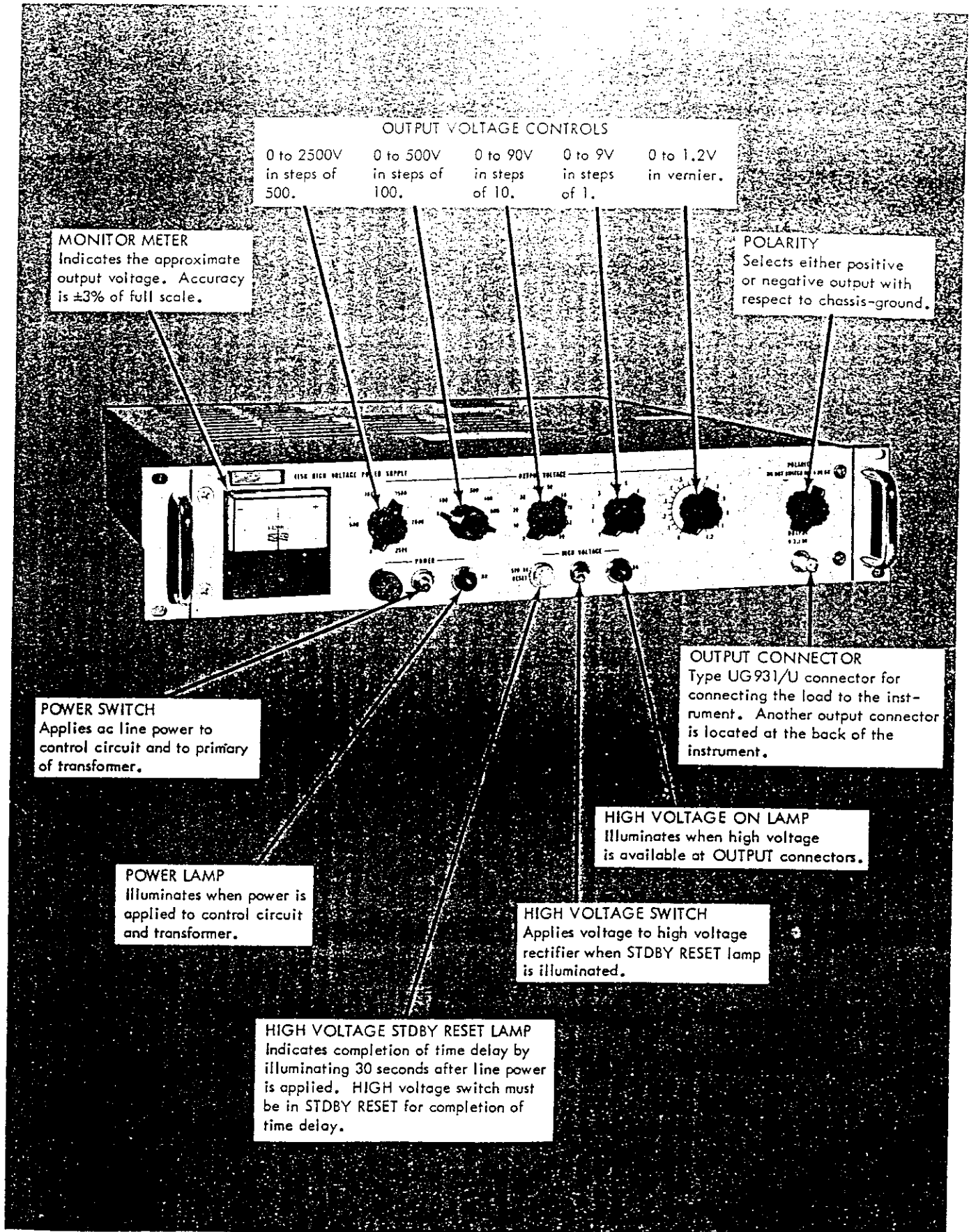

Figure 2-1. CONTROLS, TERMINALS, AND INDICATORS

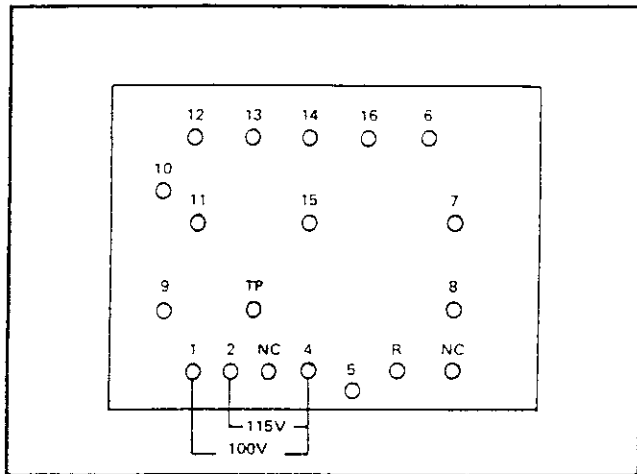

Figure 2-2. POWER TRANSFORMER TERMINALS

CAUTION!

If the output exceeds 593 volts immediately set the HIGH VOLTAGE switch to STDBY/RESET.

- f. If the output is within tolerance the instrument may be operated as in paragraph 2-11. If the output is not within tolerance, troubleshoot the instrument as described in paragraph 4-35.

2-11. OPERATING PROCEDURES

- Set the POWER switch to ON. The ON lamp will illuminate.
- Set the HIGH VOLTAGE switch to STDBY/RESET. After approximately 30 seconds the time-delay relay will close and the STDBY/RESET lamp will illuminate.
- Set the POLARITY switch to the desired polarity.
- Set the OUTPUT VOLTAGE dials to the desired output.

CAUTION!

Rapidly decreasing the setting of the OUTPUT VOLTAGE dials with the high voltage on may damage the sampling string resistors. When dialing down the output voltage, pause approximately 1/2 second in each switch position

- Connect the load circuit securely to the output connector. Check the external circuit for conflicts in grounding before applying power to the load.

WARNING!

This power supply can produce lethal voltage. Always set the HIGH VOLTAGE switch to STDBY/RESET and wait until the output voltage has decayed to zero before connecting or disconnecting the load.

- After the STDBY/RESET lamp illuminates, set the HIGH VOLTAGE switch to ON. The STDBY/RESET lamp will extinguish and the HIGH VOLTAGE ON lamp will illuminate. The panel meter will indicate the approximate output voltage.

NOTE!

If the overcurrent trip level has been reduced from the factory setting of 32 ma, it may be necessary to set the HIGH VOLTAGE switch to ON with a reduced output voltage setting, to prevent actuating the overcurrent trip when the HIGH VOLTAGE switch is set to ON. In this case, step d, above, would follow step f. If the HIGH VOLTAGE switch is set to ON immediately after the STDBY/RESET lamp illuminates any overload will cause the output voltage to oscillate between ON and STDBY/RESET. The oscillation can be stopped or prevented by correcting the overload condition.

- To remove the high voltage from the output connector, set the HIGH VOLTAGE switch to STDBY/RESET.

NOTE!

When the HIGH VOLTAGE switch is in the STDBY/RESET position, there may be a voltage of 2 to 3 volts at the output connector. This voltage will be opposite in polarity to the setting of the POLARITY switch, and is due to current flow through the reference network R25 and CR4 and the absence of current in the voltage control string.

- The output polarity of the Model 415B may be changed at any time when no load is connected to the instrument. When a load is connected, especially one that is highly reactive, the HIGH VOLTAGE switch should be set to STDBY/RESET, or the output voltage should be reduced to 500 volts, before changing the output polarity. If the polarity is switched at high output voltages with reactive loads, the POLARITY switch may be damaged.
- The Model 415B is protected from overload damage by an overcurrent protection circuit which removes power from the high voltage rectifiers at an output current of 32 milliamperes, or at the value set during calibration of the instrument. When the overload trip is actuated, the HIGH VOLTAGE ON lamp will extinguish. The high voltage may be re-applied to the output connectors as follows:

- Set the HIGH VOLTAGE switch to STDBY/RESET. After approximately 30 seconds the STDBY/RESET lamp will illuminate.
- Set the HIGH VOLTAGE switch to ON. The STDBY/RESET lamp will extinguish and the HIGH VOLTAGE ON lamp will illuminate. The output voltage will be available at the output connectors.

NOTE!

To obtain best output stability from the Model 415B, the HIGH VOLTAGE switch should be set to STDBY/RESET and the POWER switch left ON. This will maintain an even distribution of heat within the unit and prevent the need for recurrent warmups. For highest stability applications, the OUTPUT VOLTAGE dials should be set to the desired voltage and the HIGH VOLTAGE switch left ON.

2-12. APPLICATIONS**2-13. Calibration of Meters**

2-14. The Model 415B may be used for direct calibration of dc instruments to an accuracy of 0.25% or 100 millivolts (whichever is greater) at 3100 cardinal points, 1 volt apart, from 0 to 3099 volts. The vernier dial provides an additional 1.2 volts of range for calibration between cardinal points. Proceed as follows:

- a. Set the POLARITY switch to the desired polarity.
- b. Connect the instrument being calibrated firmly to the power supply. Check the external circuit for conflicts in grounding before applying power to the load.
- c. Set the HIGH VOLTAGE switch to ON. The STDBY/RESET lamp will extinguish and the HIGH VOLTAGE ON lamp will illuminate.
- d. Set the first four OUTPUT VOLTAGE dials to the desired cardinal point. Use the last dial if a calibration point between the one volt cardinal points is desired.
- e. To remove the output voltage from the output connector, set the HIGH VOLTAGE switch to STDBY/RESET.

2-15. When used with a John Fluke differential voltmeter and voltage divider, the 415B is capable of calibrating dc instruments from 0 to 3100 volts with an accuracy of 0.01% to 0.06% with 5 millivolts resolution. For calibration of instruments from 0 to 1100 volts, proceed as follows:

- a. Set the POLARITY switch to the desired polarity.
- b. Connect the instrument being calibrated securely to the power supply. Check the external circuit for conflicts in grounding before applying power to the load.
- c. Connect a John Fluke differential voltmeter to the instrument being calibrated.
- d. Set the differential voltmeter to measure the voltage desired at the calibration point.
- e. Set the HIGH VOLTAGE switch to ON. The STDBY/RESET lamp will extinguish and the HIGH VOLTAGE ON lamp will illuminate.

- f. Null the differential voltmeter by adjusting the OUTPUT VOLTAGE dials. The accuracy of the voltage measured is from 0.01% to 0.05%, depending on the accuracy of the differential voltmeter used.
- g. Set the HIGH VOLTAGE switch to STDBY/RESET.
- h. Repeat steps d. through g. for as many calibration points as desired.

2-16. For calibration of instruments from 1100 volts to 3100 volts, proceed as follows:

- a. Set the POLARITY switch to the desired polarity.
- b. Connect the instrument being calibrated firmly to the power supply. Check the external circuit for conflicts in grounding before applying power to the load.
- c. Connect a John Fluke Model 80N-5 Voltage Divider to the instrument being calibrated and connect the differential voltmeter to the voltage divider output terminals.
- d. Set the differential voltmeter to measure the voltage at the desired calibration point, considering the ten-to-one division ratio of the voltage divider.
- e. Set the HIGH VOLTAGE switch to ON. The STDBY/RESET lamp will extinguish and the HIGH VOLTAGE ON lamp will illuminate.
- f. Null the differential voltmeter by adjusting the OUTPUT VOLTAGE dials. The accuracy of the voltage measured is from $\pm 0.02\%$ to $\pm 0.06\%$, according to the accuracy of the differential voltmeter and voltage divider used.
- g. Set the HIGH VOLTAGE switch to STDBY/RESET.
- h. Repeat steps d. through g. for as many calibration points as desired.

2-17. Operation with a Reference Divider

2-18. When the output of the Model 415B is compared to a standard cell by way of a reference divider, the Model 415B can be set to provide voltages of an accuracy greater than the inherent accuracy of the instrument. When used with the Model 750A Reference Divider and the Model 845AB Voltmeter/Null Detector, the Model 415B can provide voltages 0.1, 0.5, 1.0, 5, 10, 100, 500, 1000, and 1100 volts which have an accuracy of 10 to 20 ppm, and are traceable to the National Bureau of Standards. Connect the equipment as shown in Figure 2-3 and proceed as follows:

- a. Set the Model 415B HIGH VOLTAGE switch to STDBY/RESET and the POWER switch to ON.
- b. Set the Model 750A STANDARD CELL dials to the voltage value of the standard cell being used.
- c. Set the Model 750A INPUT VOLTAGE switch to 1100 volts or the highest voltage desired.

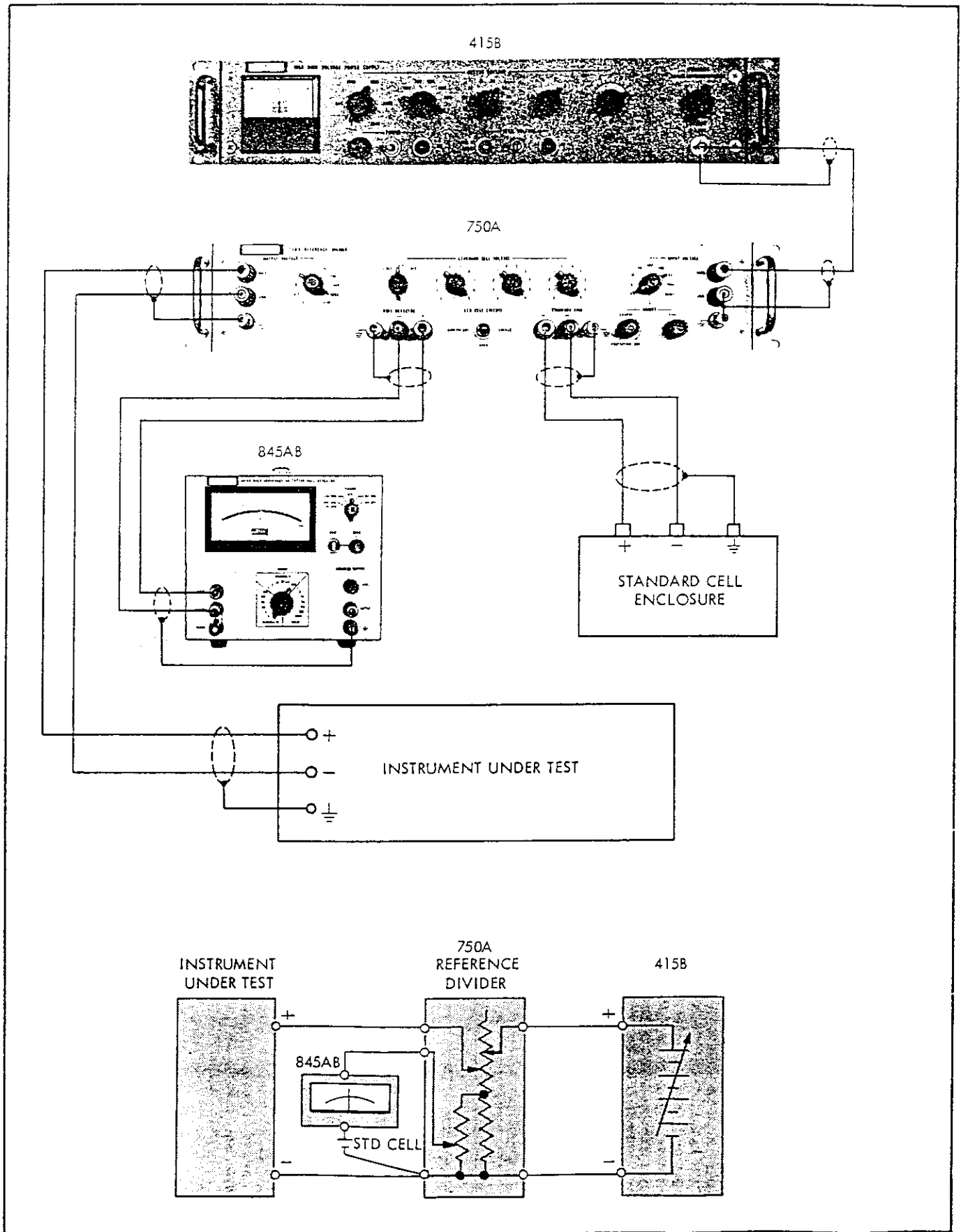

Figure 2-3. OPERATION WITH A REFERENCE DIVIDER

- d. Set the Model 750A COARSE and FINE controls to mid-position.
- e. Set the Model 415B POLARITY switch to the desired polarity and the OUTPUT VOLTAGE controls to same voltage value as the Model 750A INPUT control.
- f. Set the Model 845B controls as follows:

POWER	ON
OPR/ZERO	OPR
RANGE	To reduced sensitivity (1 volt for example)
- g. Set the Model 415B HIGH VOLTAGE switch to ON. Throw the STANDARD CELL switch on the Model 750A to MOMENTARY and note the deflection on the Model 845AB. Then adjust the Model 415B OUTPUT CONTROLS, including the vernier, to achieve zero indication on the Model 845AB. Increase sensitivity of the Model 845AB as null is approached.
- h. Using the COARSE and FINE controls on the Model 750A, adjust for a final null on the 10 microvolt range of the Model 845AB.
- i. Calibrated output voltages are now available at the Model 750A OUTPUT VOLTAGE terminals. The desired voltage value is selected with the Model 750A OUTPUT VOLTAGE control.

2-19. Leakage Current Measurements

2-20. The Model 415B, in conjunction with any John Fluke differential voltmeter, may be used to determine

leakage current at high voltage in insulators, capacitors and test instruments. Proceed as follows:

- a. Connect the equipment as shown in Figure 2-4. The protection circuit shown in Figure 2-4 provides protection to the voltmeter by limiting the input to less than one volt in the event of a short in the component under test. The resistors must be non-inductive (composition, Allen Bradley type).
- b. Set the differential voltmeter to measure 100 millivolts.
- c. Set the HIGH VOLTAGE switch to ON. When the HIGH VOLTAGE lamp illuminates gradually increase the output of the Model 415B until the desired test voltage or limit of leakage current is obtained.
- d. An indication of 100 millivolts on the voltmeter indicates a leakage current of 0.1 microamperes and corresponds to a measured resistance of 3×10^{10} ohms when 3000 volts is applied from the Model 415B.

2-21. Circuit Protection

2-22. The overcurrent protection circuit of the Model 415B is adjusted at the factory to operate 32 milliamperes load current. This adjustment is accessible through the top cover and may be set to operate at other load currents up to 35 milliamperes. To re-adjust the overcurrent circuit to operate at a load current other than 32 milliamperes, refer to paragraph 4-33.

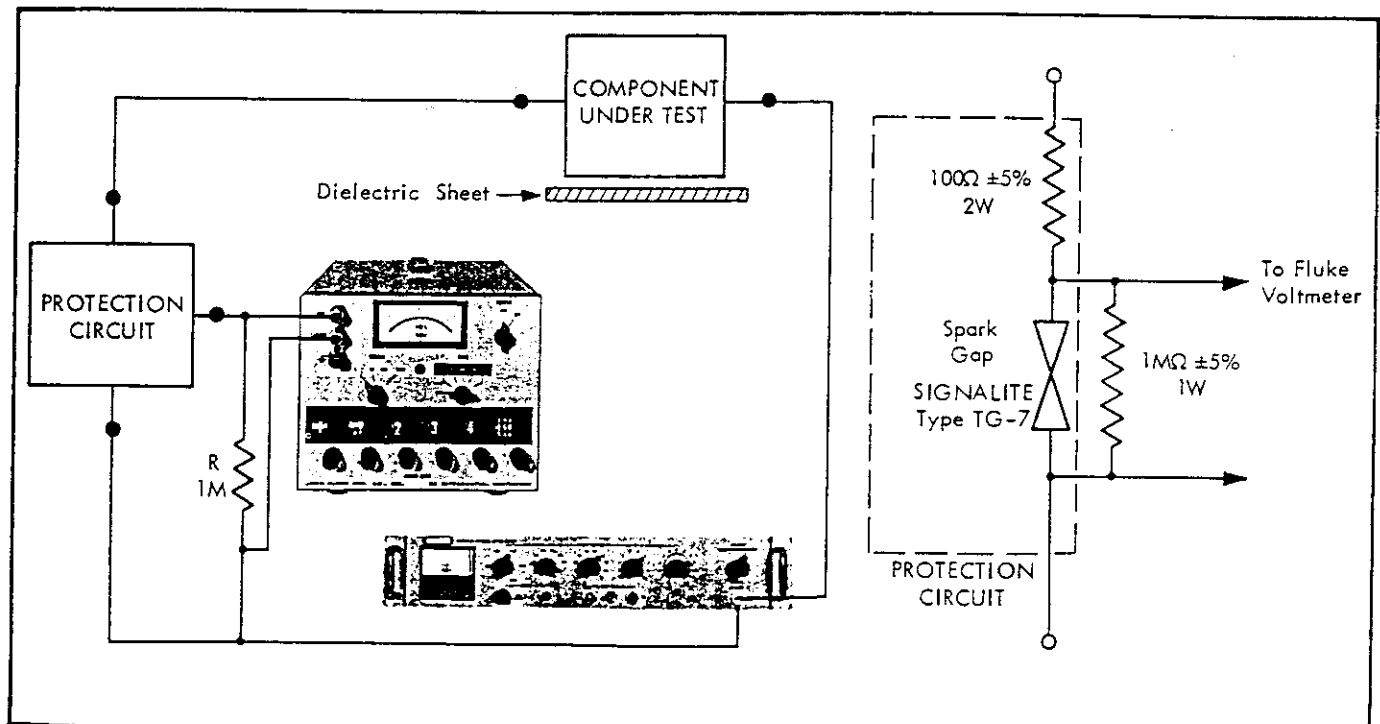

Figure 2-4. LEAKAGE CURRENT TESTING

Section 3

Theory of Operation

3-1. INTRODUCTION

3-2. This section describes the theory of operation of the Model 415B. Refer to the block diagram, Figure 3-1, and to the functional schematic diagram in conjunction with this text. The schematic is located in the rear of this manual, following Section V.

3-3. BLOCK DIAGRAM ANALYSIS

3-4. The Model 415B high voltage power supply consists basically of a power transformer, high-voltage rectifier, series pass regulator, error amplifier, reference divider and voltage control resistor string. It also includes a time delay circuit, auxiliary power supply, +125 volt regulator, temperature-compensated reference voltage, overcurrent protection circuit and a voltmeter.

3-5. The input line voltage passes through the power transformer and is converted to output dc voltage and auxiliary dc support voltages. A 30-second delay is imposed on application of ac to the high voltage rectifier.

3-6. The high voltage dc appears across the series pass tubes and the output terminals. The magnitude of output voltage is set by varying the resistance of the voltage control string, and is maintained at this level by varying the conduction of the series pass tubes in response to control signals from the error amplifier.

3-7. The voltage control circuits include the reference tube, reference network, voltage control resistor string and the error amplifier. The reference tube provides a constant current to the reference network and voltage control resistors which are connected in series to the common output buss. One input to the error amplifier is the summation junction of the reference network and the voltage control string. The other input is connected to the positive output buss. Any voltage difference between the two inputs is amplified, and used to drive the series pass tubes which maintain the output voltage constant. The front panel meter provides an indication of output level.

3-8. CIRCUIT DESCRIPTIONS

3-9. Time Delay

3-10. When the POWER switch is set to ON, ac is applied to the series pass tube filaments and to the auxiliary supply. There is a 30 second delay before high voltage can be supplied. This permits the auxiliary voltages to reach operating level and insures that voltage control circuits have control when high voltage is applied. This delay is provided by K1 on the High Voltage Rectifier Assembly; K1 operates only if the HIGH VOLTAGE switch S2 is in STDBY/RESET position. The dc output common buss is also open circuited when power is first turned on. To close the output buss, the time delay must be completed and relay K4 operated by the HIGH VOLTAGE switch.

3-11. In referring to the functional schematic, it should be noted there are two ground return symbols in the primary circuit of the power transformer. The ac return (∇ ac) connects the low side of the primary to the low side of the power line through the POWER switch S1. The dc return (∇ R) completes the return path of the half-wave rectifier consisting of CR1, R1, R3 and C1. This rectifier supplies dc to operate relays K2, K3 and K4 on the High Voltage Rectifier P/C Assembly. When the time delay cycle is completed, dc is supplied to K2. Contact K2B opens and removes the time delay relay from the circuit. Contacts K2A and K2C close and K2A illuminates the STDBY/RESET lamp. When the HIGH VOLTAGE switch is set to ON position, the HIGH VOLTAGE lamp illuminates and relays K3 and K4 are operated from contact K2C. Contacts K3A and K3B complete the ac circuit of the high voltage rectifier. Contacts K4A and K4B complete the dc output circuit.

3-12. High Voltage Rectifier and Series Pass

3-13. The multitap high voltage winding of the power transformer provides voltage to the high voltage rectifier according to the position of the first OUTPUT VOLTAGE switch. The multitap feature provides approximate control of the unregulated dc output of the

high voltage rectifier and minimizes the power dissipation required of the series pass tubes at low output voltage. The high voltage rectifier filter consists of CR2 through CR23 on the High Voltage Rectifier P/C Assembly in addition to C7, C8 and R1 through R6 on the Bleeder P/C Assembly. This circuit forms a voltage doubler configuration which provides filtered but unregulated dc voltage to the series pass tubes V1 and V2. The parallel-connected series pass tubes maintain the output voltage at the value set on the control dials by altering tube conduction in response to control signals from the error amplifier.

3-14. Error Amplifier

3-15. The error amplifier consists of Q6, Q7 and Q8 on the Amplifier P/C Assembly and Q1 through Q4 on the Series Pass P/C Assembly and their associated circuitry. Q7 and Q8 form a differential amplifier. The input to Q7 is from the positive output buss; the input to Q8 is from the summation point at the junction of the voltage control resistors and the reference network. Any voltage change at the output buss appears as a voltage difference between the bases of Q7 and Q8 and alters the collector current of Q8. This change appears as error signal at the base of the common emitter amplifier Q6. The output of Q6 is fed back to the base of Q7 for loop stabilization and to the compound-connected emitter follower stage Q3 and Q4 located on the Series Pass P/C Assembly (A5).

3-16. Q3 and Q4 provide current drive and impedance match between the high collector impedance of Q6 and the low emitter impedance of Q2. The cascaded common base amplifiers Q1 and Q2 provide the voltage gain necessary to swing the grids of the series pass tubes, V1 and V2, through the required range.

3-17. Reference Tube and Resistor Network

3-18. The reference tube, V1, is a specially selected and aged type 83A1. V1 is provided with a temperature-compensation network, R14 and R15, so that its output is a constant voltage. Since the summation point is always at zero volts, V1 causes a constant current to flow through the reference network. This same constant flows through the voltage control resistors, and the output voltage is equal to the IR drop across these resistors. The output voltage may thus be precisely controlled by varying the resistance of the voltage control string.

3-19. Auxiliary Supply

3-20. AC voltage for both positive and negative auxiliary dc supplies is provided by a single transformer winding. One terminal of this winding is connected to the positive output buss; the other terminal is connected via R2 to the junction of CR1 and CR2. Diodes CR1 and CR2, on the Series Pass P/C Assembly, and C1 and C2, on the Amplifier P/C Assembly comprise a voltage doubler. The output of the doubler is impressed across a network consisting of R3, R4 and R5, and zener diodes CR3 through CR6. This arrangement provides regulated dc voltages of +95, +20, +10 and -110 volts. The raw dc +125 volt output of the supply is fed to the regulator on the Amplifier P/C Assembly.

3-21. +125 Volt Regulator

3-22. The +125 volt regulator consists of Q1 through Q5 and their associated circuitry on the Amplifier P/C Assembly. Q4 and Q5 comprise a differential amplifier. Q2 is an emitter follower regulator which serves as a 100 volt source for the emitter of Q3 and the collector of Q4. The bases of Q4 and Q5 are held at a constant 83 volts by the reference tube V1. The base of Q4 also samples the +125 volts dc through the divider R8 and R9. Any difference in voltage between the bases of Q4 and Q5 appears as error signal at the base of Q3. Q3 provides further gain to the signal which is applied to the series regulator Q1. Zener diode CR1 provides regulated dc to Q3 and bypasses a part of the current to decrease dissipation of Q1.

3-23. Overcurrent Protection

3-24. Protection to the instrument from damage by excessive current is provided by relay K1 located on the Bleeder P/C Assembly. K1 is in series with the common output lead and is normally adjusted to operate at 32 milliamperes by R5 located on the High Voltage Rectifier P/C Assembly. Adjustment R5 divides the load current between K1 and the relay shunting resistors R5 and R6. The contacts of K1 are connected across the coil of K2 on the High Voltage Rectifier P/C Assembly and de-energize this relay. In order for high voltage to be re-applied the overload must be removed and the time delay permitted to complete its cycle.

3-25. ACCURACY

3-26. The main sampling string resistors in the Model 415B are accurate to within $\pm 0.1\%$. The accuracy of the Model 415B, however, is specified as $\pm 0.25\%$ because the instrument accuracy also depends upon the repeatability and stability of the reference voltage and the length of on-time of V1. The output voltage of V1 changes slightly with time due to aging. The accuracy of the instrument will remain within $\pm 0.25\%$ for greater than 30 days. The calibration accuracy may be maintained at better than $\pm 0.25\%$ if the supply is recalibrated more often than the usual calibration period of 30 days.

3-27. The overall accuracy of the meter in the Model 415B is approximately $\pm 3\%$ of meter input, including the tolerances of multiplying and shunting resistors. However, the calibrated voltage controls should be relied upon to indicate the value of the output voltage. For example, if an output voltage of 1000 volts is selected, the meter will indicate between 970 volts and 1030 volts ($\pm 3\%$ of 1000-30). However, the actual output voltage will be between 997.5 volts and 1002.5 volts ($\pm 0.25\%$ of 1000 ± 2.5).

3-28. All calibrated power supplies have an accuracy limit (floor) as the output voltage approaches zero. This floor is caused by zero shift in the error amplifier, contact resistance in the sampling string circuit, and the accuracy of the voltage-control resistors used for the least significant digits. The Model 415B has an accuracy of $\pm 0.25\%$ or 100 mv, whichever is greater, with the vernier at zero. Thus, the $\pm 0.25\%$ accuracy is valid down to 40 volts.

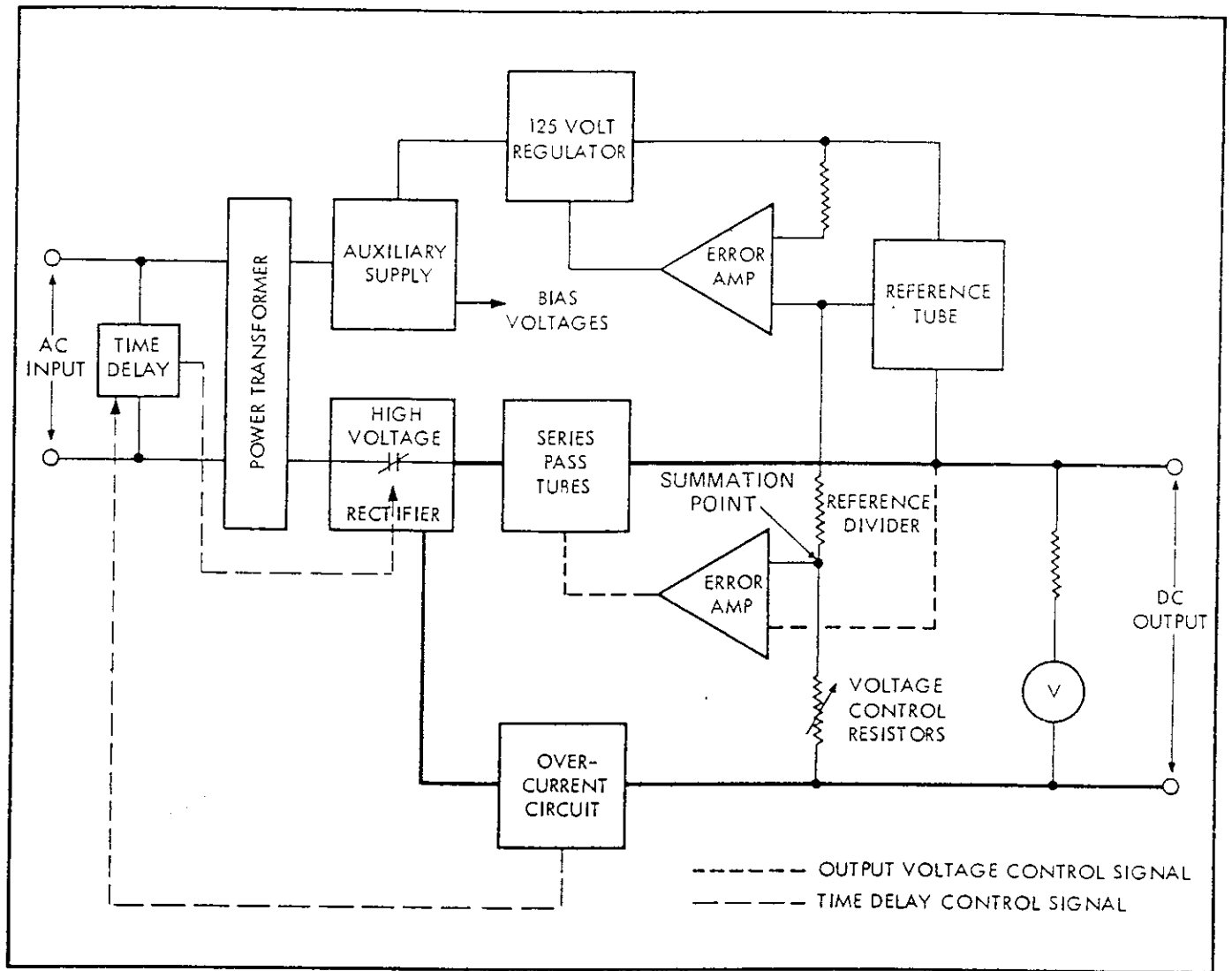

Figure 3-1. MODEL 415B BLOCK DIAGRAM

Section 4

Maintenance

4-1. INTRODUCTION

4-2. This section contains information concerning maintenance and calibration of the Model 415B. General and unique maintenance procedures are given in paragraphs 4-6 through 4-14. Test equipment required for maintenance is given in paragraph 4-15. Performance tests are given in paragraph 4-17; calibration procedures are given in paragraphs 4-29 through 4-34. Troubleshooting information is contained in paragraph 4-35.

4-3. SERVICE INFORMATION

4-4. Each instrument manufactured by the John Fluke Mfg. Co., Inc. is warranted for a period of one year upon delivery to the original purchaser. Complete warranty information is contained in the warranty page located in the rear of this manual.

4-5. Factory authorized calibration and repair service for all Fluke instruments are available at various world wide locations. A complete list of factory authorized service centers is located at the rear of the manual. If requested, an estimate will be provided to the customer before any repair work is begun on instruments beyond the warranty period.

4-6. GENERAL MAINTENANCE

4-7. Maintenance of the Model 415B consists primarily of occasional cleaning, tube replacement and calibration. Removal of the top cover opens the interlock switch. To have high voltage applied, the interlock must be disabled.

DANGER!

Hazardous voltages exist in this instrument! The metal shells of some electrolytic capacitors may be elevated to 3185 volts above ground. Before servicing or removing tubes, short all electrolytic capacitors and plate caps to the chassis. Use a 1,000 ohm 2 watt resistor in the shorting lead.

4-8. Cleaning

4-9. Periodic cleaning of the Model 415B is desirable.

Any contamination, particularly on the high voltage capacitors, will cause corona discharge which will appear as noise in the output voltage. Removal of dust with low pressure compressed air or a vacuum cleaner should be all that is normally required.

4-10. Components may be cleaned using Freon TF Degreaser (Miller-Stephenson Chemical Co.), or with a cloth saturated with denatured alcohol.

4-11. Circuit Board Sealant

4-12. The land pattern side of all printed circuit boards in the Model 415B has been treated with Epocast (a polyurethane resin) to inhibit fungus growth and moisture-absorption. When soldering to a printed circuit land, the heat from the soldering iron decomposes the Epocast resin, leaving a charred residue. Upon completion of soldering, this residue should be removed with a solvent, such as toluol.

CAUTION!

When using toluol, avoid inhaling the vapors, avoid excessive contact with the skin, and keep away from open flames. Insure that plastic components do not come in contact with toluol, since it will dissolve most types of plastics.

After removal of Epocast residue, the affected area should be recoated with a sealant. A spray can of Circuit Coat (Furane Plastic Inc., 4516 Brazil Street, Los Angeles, California or 16 Spielman Road, Fairfield, New Jersey) may be used for recoating.

4-13. Fuse Replacement

4-14. Listed below is the correct replacement for the line power fuse. Use only the correct rating as a replacement.

LINE VOLTAGE	TYPE
115 vac	3 amp, slow blow
230 vac	1.5 amp, slow blow

4-15. TEST EQUIPMENT REQUIRED FOR MAINTENANCE

4-16. The test equipment required for maintenance is listed in Figure 4-1. Equivalent or similar units may

REQUIRED EQUIPMENT	SPECIFICATIONS REQUIRED
Autotransformer or Variac	Output of 0-130 volts at 3 amperes or 0-260 volts at 1.5 amperes.
DC Differential Voltmeter - Fluke Model 885A	Accuracy of 0.0025%, 0-1000 volts.
Voltage Divider - Fluke Model 80F-5	Accuracy of 0.01%, input voltage to 5000 volts.
RMS Voltmeter - Fluke Model 931A	Capable of measuring non-sinusoidal voltages of less than 100 microvolts.
Oscilloscope - Tektronix Type 541 with Type D Plug-In Unit	1 millivolt/centimeter sensitivity.
VTVM - RCA Voltohmyst	DC accuracy $\pm 3\%$.
DC Blocking Capacitor	0.05 uf minimum capacity, 5000 volts dc
Power Resistor	16.7 kilohms $\pm 5\%$, 15 watts.
Composition Resistors	1,000 ohms $\pm 5\%$, 2 watts. 100 ohms $\pm 5\%$, 2 watts. 1 megohm $\pm 5\%$, 1 watt.
Silicon Diodes - Two required	Type 1N4818 or equivalent with 50 amperes surge capability and no greater than 20 pf capacity.
Preamplifier - Tektronix Type 123	Gain of 100 with low level noise and hum.
Battery	1.5 volts.

Figure 4-1. TEST EQUIPMENT REQUIRED FOR MAINTENANCE AND CALIBRATION

be substituted provided they have the required specifications given in the figure.

4-17. PERFORMANCE TESTS

4-18. Introduction

4-19. The following tests are intended for checking the performance of the Model 415B. These tests may be used for incoming inspection, periodic inspection and precalibration checks. It is recommended that these tests be performed after circuit repair and before each calibration.

4-20. The load, line and ripple checks do not depend on any calibration adjustments, and a fault detected by testing can usually be isolated by performing the checks in the subsection covering troubleshooting. Minor errors in accuracy of the output voltage may be corrected by adjustment of the reference current, paragraph 4-30. Should the adjustment be ineffectual or at a limit, you must investigate the cause of the problem.

4-21. Preliminary Procedure

- Connect the power plug of the Model 415B to the output of an autotransformer and connect the input to the autotransformer to 115 volts, 60 Hz line power.
- Set the autotransformer for an output of 115 volts.

4-2

- Perform the procedures described in paragraph 2-9, Initial Operation.

4-22. STABILITY. This test measures the deviation in output voltage over a specified time period. This deviation is due to the internal temperature rise of the unit.

- Set the controls of the Model 415B as follows:

POWER	ON
HIGH VOLTAGE	STDBY/RESET
POLARITY	Positive
OUTPUT VOLTAGE	First dial to 2500;
dials	second dial to 500;
	all others to zero

- Connect the input of the Model 885A across the output of the Model 80F-5 voltage divider and connect the divider input to the OUTPUT connector of the Model 415B.
- Set the HIGH VOLTAGE switch to ON. Operate the instrument for at least 60 minutes.
- Adjust the Model 885A for a null and record the output indication.
- Operate the instrument for an additional 60 minutes. Again, measure the output voltage. The difference between the two voltages should be no greater than 60 millivolts (6 millivolts at 10:1 divider output terminals).

NOTE!

The unit must have been operated for one hour before testing to the following requirements. The cover must be in place during the ripple test.

4-23. **OUTPUT AT ZERO VOLTS.** This test checks for imbalance in the voltage control circuit.

a. Set the controls of the Model 415B as follows:

POWER	ON
HIGH VOLTAGE	STDBY/RESET
POLARITY	Negative
OUTPUT VOLTAGE	All zeros
dials	

b. Connect the Model 885A across the OUTPUT connector.

c. Set the HIGH VOLTAGE switch to ON. The Model 885A at null should indicate no more than 50 millivolts for both polarities.

4-24. **LINE REGULATION.** This test determines whether the deviation in output is within specified limits for a change from low to high line voltage.

a. Set the controls of the Model 415B as follows:

POWER	ON
POLARITY	Positive
OUTPUT VOLTAGE	Second dial to 500;
dials	all others to zero.

b. Adjust the autotransformer for 103 volts output. Adjust the Model 885A for a null indication.

c. Increase the line voltage to 127 volts. The output voltage change indicated by the Model 885A shall be less than 3 millivolts (6 ppm).

d. Set the HIGH VOLTAGE switch to STDBY/RESET and disconnect the Model 885A from the OUTPUT connector.

e. Set the autotransformer output to 103 volts. Set the first OUTPUT VOLTAGE dial to 2500, the second dial to 500 and all others to zero.

f. Connect the output terminals of the Model 80F-5 voltage divider to the input of the Model 885A and connect the divider input across the Model 415B OUTPUT connector.

g. Set the HIGH VOLTAGE switch to ON and adjust the Model 885A for null indication.

h. Increase the line voltage to 127 volts. The voltage change indicated by the Model 885A should be no more than 1.8 millivolts (6 ppm) at the 10:1 divider output.

4-25. **LOAD REGULATION.** This test determines whether the output deviation is within specified limits for a load change from no load to full load. Before performing the Load Regulation Test, verify current limit trip point is 30 milliamps or greater. If it is not, adjust it according to the procedure in paragraph 4-33.

NOTE!

Meter readings will vary with contact resistance. Make comparative readings with load on Front and rear output terminals.

a. Set the controls of the Model 415B as follows:

POWER	ON
HIGH VOLTAGE	STDBY/RESET
POLARITY	Positive
OUTPUT VOLTAGE	Second dial to 500;
dials	all others to zero

b. Connect the Model 885A across the front panel OUTPUT connector.

c. Adjust the autotransformer for 103 volts output.

d. Set the HIGH VOLTAGE switch to ON. Adjust the Model 885A for a null indication.

e. Connect a 16.7K ohm resistor across the rear panel OUTPUT connector. The voltage change indicated by the Model 885A shall be less than 2.0 millivolts.

NOTE!

Meter readings will vary with contact resistance. Make comparative readings with load on front and back output terminals.

f. Disconnect the load resistor and see the POLARITY switch to negative.

g. Repeat the measurements of steps d and e.

4-26. **RIPPLE.** This test determines whether the residual ac component superimposed on the dc output is within specified limits. Ripple is usually higher with negative polarity output. Proceed as follows:

a. Set the controls of the Model 415B as follows:

POWER	ON
HIGH VOLTAGE	STDBY/RESET
POLARITY	Negative
OUTPUT VOLTAGE	Second dial to 500;
dials	all others to zero

b. Connect the 5,000 volt blocking capacitor and the protection circuit shown in Figure 4-2 between the OUTPUT connector and the inputs to the Model 931B RMS voltmeter and the oscilloscope. This circuit protects the input circuitry of the oscilloscope and the voltmeter from a 3000 volt charge on the blocking capacitor if the Model 415B output is accidentally shorted.

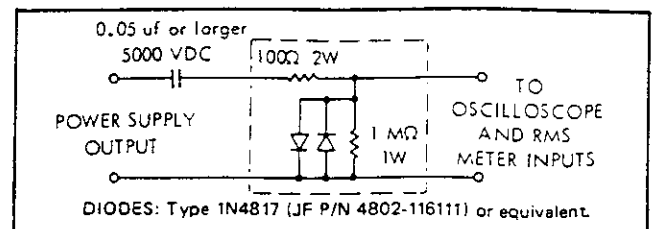

Figure 4-2. PROTECTION CIRCUIT

- c. Set the HIGH VOLTAGE switch to ON. The ripple indication shall be less than 1.0 millivolt peak-to-peak and less than 100 microvolts RMS.
- d. Adjust the line voltage from 103 to 127 volts and observe the ripple indication. Ripple shall be within the limits specified in step c.
- e. Set the first OUTPUT VOLTAGE dial to 2500, the second dial to 500 and other dials to zero.
- f. Vary the output of the autotransformer between 103 and 127 volts and observe the ripple indication. Ripple shall be within the limits specified in step c.

4-27. OUTPUT VOLTAGE ACCURACY. To determine the accuracy of output at each OUTPUT VOLTAGE switch setting, perform the procedures of paragraphs 4-30 and 4-31, deleting the adjustments.

4-28. OVERCURRENT CHECK. To check the trip point of the overcurrent circuit, perform the procedures of paragraph 4-33, deleting the adjustments.

4-29. CALIBRATION

4-30. 3000 Volt Adjustment

4-31. Before making calibration adjustments, the unit must have been operated at normal line voltage for at least one hour with an output of 3100 volts. Proceed as follows:

- a. Set the output of the autotransformer to 115 volts and set the controls of the Model 415B as follows:

POWER	ON
POLARITY	Negative
HIGH VOLTAGE	STDBY/RESET
OUTPUT VOLTAGE dials	First dial to 2500; second dial to 500; others to zero
- b. Connect the output terminals of the Model 80F-5 voltage divider across the input terminals of the Model 885A. Connect the divider input across the Model 415B OUTPUT connector.
- c. Set the HIGH VOLTAGE switch to ON and adjust the Model 885A to measure 300 volts.
- d. Adjust R26 on the Amplifier P/C Assembly for a null indication on the Model 885A. This adjustment is accessible through the hole in the top cover. Make the adjustment to better than ± 100 millivolts of 3000 volts (± 10 millivolts on the Model 885A).

CAUTION!

Use an insulated screwdriver to adjust R26. With negative output polarity, the case of this resistor is 83 volts above chassis ground. With positive polarity output, the case would be 3083 volts above chassis ground.

- e. If the potentiometer is at its limit or the adjustment can not be achieved, refer to paragraphs 4-46 and 4-48.

- f. Set the POLARITY switch to Positive and observe that the output is within the limits of step d. Do not adjust!

4-32. LINEARITY CHECK. Proceed as follows:

- a. Set the first OUTPUT VOLTAGE dial to the 2500 volt position and all other dials to zero. Connect the voltmeter-voltage divider combination across the OUTPUT connector.
- b. Step down the first dial and observe that the voltmeter null indication is within the limits given in Figure 4-3. Discontinue use of divider after 1500 volt step; connect the voltmeter directly to OUTPUT connector.
- c. Repeat the measurement of step b for the second and third decades.

DIAL	OUTPUT VOLTAGE STEP	NULL READING TOLERANCE
500 VOLT STEPS	2500	250 millivolts ①
	2000	200 millivolts ①
	1500	150 millivolts ①
	1000	1.0 volts
	500	0.5 volts
100 VOLT STEPS	400	400 millivolts
	200	200 millivolts
	100	100 millivolts
10 VOLT STEPS	80	80 millivolts
	60	60 millivolts
	40	50 millivolts
	20	50 millivolts
	10	50 millivolts
NOTE: ① Tolerance applies to 10:1 divider output.		

Figure 4-3. LINEARITY TEST: 500, 100 AND 10 VOLT STEPS

- d. Dial the 1-volt step decade from zero to the 9 volt position. Observe that the output voltage increases in even steps. Output voltage at 9-volt setting should be 8.95 to 9.05 volts.
- e. Set all OUTPUT VOLTAGE dials to zero, then turn the vernier control to maximum output. The Model 885 indication should be between 1.05 and 1.35 volts.
- f. Check the resolution of the vernier by adjusting the output to 1.0 volt. It should be possible to adjust the vernier to within ± 5 millivolts of a 1.0 volt null on the Model 885A.

4-33. OVERLOAD CURRENT. To check and adjust the overload current circuit proceed as follows:

- a. Set the controls of the Model 415B as follows:

POWER	ON
POLARITY	Negative

OUTPUT VOLTAGE Third dial to 20;
dials Fourth dial to 5;
other dials to zero

HIGH VOLTAGE STDBY/RESET

- b. Connect a 1,000 ohm, 2 watt, resistor across the OUTPUT connector.
- c. Set the HIGH VOLTAGE switch to ON. The STDBY/RESET lamp shall extinguish and the HIGH VOLTAGE lamp shall illuminate.
- d. Increase the output voltage in 1 volt step. The overload circuit should operate and extinguish the HIGH VOLTAGE lamp within the range of 29 to 35 volts. If the trip point is beyond this range, adjust as follows:
- e. Set the HIGH VOLTAGE switch to STDBY/RESET.
- f. Set the unit for maximum current by turning R5 fully counter-clockwise. This control is located on the High Voltage Rectifier P/C board and is accessible through a vent on the left-hand side of the unit.
- g. Set the OUTPUT VOLTAGE dials to 32 volts.

NOTE!

This voltage will provide 32 milliamperes to the 1,000 ohm load resistor. If it is desired that overcurrent trip should occur at a lower current, choose the output voltage to provide the reduced current.

- h. Using an insulated screwdriver, slowly turn R5 clockwise until the overload circuit trips and extinguishes the HIGH VOLTAGE lamp.
- i. Set the HIGH VOLTAGE switch to STDBY/RESET. Set the OUTPUT VOLTAGE dials to 25 volts, or to a comparable voltage if the adjustment was for an overload current less than 32 milliamperes.
- j. Repeat steps c and d to check the adjustment.

4-34. Meter Calibration

- a. Set the controls of the Model 415B as follows:

POWER	ON
POLARITY	Negative
OUTPUT VOLTAGE dials	First dial to 2500; second dial to 500; other dials to zero
HIGH VOLTAGE	STDBY/RESET
- b. Set the HIGH VOLTAGE switch to ON.
- c. Using an insulated screwdriver, adjust R26 on the Switch P/C board so that the panel meter indicates 3000 volts (± 90) volts.

NOTE!

It will be necessary to remove the cover and disable the cover interlock to make this adjustment.

- d. Set the POLARITY switch to Positive and check the +3000 volts indication.

4-35. TROUBLESHOOTING

4-36. Introduction

4-37. The information in the following paragraphs is intended to assist you to isolate most common troubles in the Model 415B if a systematic approach to troubleshooting is followed. A good understanding of the principles of operation is necessary to efficient troubleshooting, and it is recommended that you review Section III before attempting to troubleshoot the instrument in detail.

4-38. The following troubleshooting procedure is in such sequence that it can be applied to any unit, including one in which the trouble is totally unknown, and there is doubt whether power can be applied without causing damage. If the unit is operable, the Resistance Measurement, paragraph 4-40, and the Standby Power Check, paragraph 4-41, may be omitted. The procedure is in two parts: Isolation Checks, paragraph 4-39, and Assembly Troubleshooting, paragraph 4-45. The Isolation Checks are designed to localize most common troubles as quickly as possible. Certain key circuit parameters are checked first, which may eliminate a large portion of the circuitry as a possible cause of the trouble. If the desired results are not achieved in the isolation check, reference is given to the appropriate assembly troubleshooting procedure.

NOTE!

When troubleshooting the unit, use negative polarity output. Most voltages are referenced to the positive bus which is grounded when the output polarity is negative. This provides some protection to the person doing troubleshooting.

4-39. Isolation Checks

4-40. RESISTANCE MEASUREMENTS. These checks verify correct resistance between transformer windings and between the shunting capacitors on the high voltage transformer. An output resistance measurement reveals a possible short circuit in the output and permits a check of sample string resistors before the unit is turned on.

- a. Connect an ohmmeter between the yellow lead on the first OUTPUT VOLTAGE dial wiper to the jade lead on the transformer terminal. The resistance should increase in even steps from approximately 360 ohms to 1.1 kilo ohms as the switch is stepped up.
- b. Connect the ohmmeter across the front panel OUTPUT connector. The meter should indicate approximately 2 kilo ohms with all OUTPUT VOLTAGE dials set to zero and the POLARITY switch set first to negative and then to positive. As each OUTPUT VOLTAGE dial is stepped up, the resistance should increase 500 ohms per volt and be approximately 1.25 meg ohms with all dials to maximum.

- c. Repeat the output resistance measurement at the rear OUTPUT connector. With all OUTPUT VOLTAGE dials set to zero, the resistance should be approximately 2 kilo ohms.

4-41. STANDBY POWER. This procedure measures power consumption in the STDBY/RESET position. It reveals possible gross faults, such as wiring errors and shorted components in the auxiliary supply, 125 volt regulator and error amplifier.

- a. Connect the Model 415B through a Variac to a 115 volt, 60 Hz, power line with a wattmeter or an ammeter in series with the ac line. Set the Variac to zero output.

- b. Set the Model 415B controls as follows:

OUTPUT VOLTAGE dials	All to zero
POWER	ON
POLARITY	Negative
HIGH VOLTAGE	STDBY/RESET

- d. Slowly increase the output of the Variac. The STDBY/RESET light should come on approximately 60 seconds after the line power reaches 103 volts. At 115 volts ac the unit should draw a nominal 25 watts (0.36 amperes); power consumption should be no greater than 35 watts.

4-42. 125 VOLT SUPPLY CHECK. A measurement of ripple on the 125 volt supply at low and high line voltage reveals quickly not only the ac superimposed on the dc output but also the capability of the circuit to regulate. The value of the output voltage should also be measured.

NOTE!

The following checks must be done with the top cover removed and the interlock disabled.

- a. Set the controls of the Model 415B as follows:

OUTPUT VOLTAGE dials	All to zero
HIGH VOLTAGE	STDBY/RESET
POWER	ON

- b. Connect an oscilloscope between the top of R8 on the Amplifier P/C Assembly and chassis ground. Adjust the Variac output between 103 and 127 volts. The ripple should be less 0.8 millivolts peak-to-peak (see Figure 4-4).
- c. Connect a differential voltmeter between R8 and chassis ground. At 115 volts ac line, the dc voltage should be between 120 and 130 volts. Over a line voltage range of 103 to 127 volts, the dc output should vary less than 2.5 millivolts from the indication at 115 volts.
- d. If the 125 volt supply fails to regulate or the value of output voltage is incorrect, refer to paragraph 4-46.

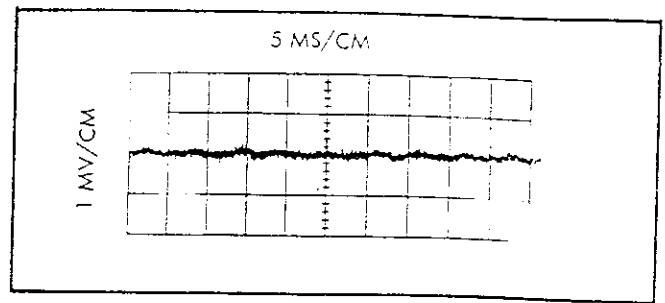

Figure 4-4. RIPPLE ON 125 VOLT SUPPLY

4-43. ERROR AMPLIFIER CHECK. This procedure determines quickly whether the Error Amplifier is operational and provides sufficient gain to drive the grids of the Series Pass tubes.

- a. Set the Variac output to 115 volts. Set the Model 415B controls as follows:

OUTPUT VOLTAGE dials	One-volt dial to one volt; all others to zero
HIGH VOLTAGE	STDBY/RESET
POLARITY	Negative
POWER	ON

- b. Connect a VTVM between either end of R8 (or R11) on the Series Pass P/C Assembly and chassis ground. The voltmeter should indicate approximately one volt positive.
- c. Connect a battery of 1.5 volts or greater to the OUTPUT connector: positive to positive and negative to negative. When the battery voltage is applied, the VTVM at the Series Pass tube grid should swing to approximately 100 volts negative (between -90 and -120 volts).
- d. The 100-volt change in step c indicates that the auxiliary power supply voltages and the Error Amplifier are probably all right. If amplifier operation is unsatisfactory, refer to paragraph 4-47.

4-44. TURN ON. This procedure checks out the High Voltage Rectifier and the Series Pass tubes.

- a. Disconnect the battery across the OUTPUT connector. Set the first OUTPUT VOLTAGE dial to 500.
- b. Set the HIGH VOLTAGE switch to ON. The line ac wattmeter/ammeter should indicate approximately 38 watts (0.52 amperes). The front panel meter should indicate approximately 500 volts.

CAUTION!

If the panel meter indicates greater than 600 volts, immediately set the HIGH VOLTAGE switch to STDBY/RESET. If the isolation procedure has been followed thus far, a possible cause of trouble is a shorted diode in the High Voltage Rectifier.

4-45. Assembly Troubleshooting

4-46. 125 VOLT REGULATOR. If the 125 volt supply fails to regulate or the value of the output voltage is incorrect, proceed as follows:

- a. With a VTVM measure the unregulated output of the auxiliary supply: junction of R3 and R4 on the Series Pass P/C Assembly. At a line voltage of 115 volts, the dc output should be 170 to 210 volts.
- b. Connect a differential voltmeter between the cathode of CR2 on the Amplifier P/C Assembly and chassis ground. Measure the output of the voltage reference tube, V1. Voltage should be between 83.3 and 85.05 volts and should remain constant over a line voltage range of 103 to 127 volts.
- c. With a differential voltmeter, measure the voltage across zener diode CR1 on the Amplifier P/C Assembly. Voltage should be 10.8 to 13.2 volts dc.
- d. In a properly operating 125 volt regulator, the bases of Q4 and Q5 should be at the same voltage (83 volt reference). If the bases are at the same voltage but the supply will not regulate, CR2 or CR3 could possibly be shorted. Eliminate this possibility with an ohmmeter check. If the supply will not regulate and CR2 and CR3 are not shorted, 0.6 volts should appear between the bases of Q4 and Q5.
- e. The transistors may be checked by repeatedly removing Q5 and measuring for a voltage transition at transistor elements at each stage following Q5. Or, substitute transistors known to be good and measure individual components with the transistors removed.
- f. If the supply will regulate within tolerance but the output voltage value is incorrect, check the voltage input to the regulator and measure the divider resistors R8 and R9, R4 and R5; these are $\pm 1\%$ resistors.

4-47. ERROR AMPLIFIER. Proceed as follows if the amplifier fails the check procedure.

- a. Set the controls of the Model 415B as follows:

OUTPUT VOLTAGE dials	All to zero
HIGH VOLTAGE	STDBY/RESET
POWER	ON
POLARITY	Negative

- b. With the VTVM measure the voltage between the following points on the Series Pass P/C Assembly and chassis ground. Remove Q1 or Q2 on the Series Pass Assembly so these voltage sources are not loaded down.

TEST	VOLTAGE
Junction of R5 and R7	-170 to -210
Cathode CR3	95 to 105
Cathode CR2	18 to 22
Anode CR6	99 to 121

- c. Replace the removed transistor, Q1 or Q2. Measure the voltage at the summing junction (front of R25). This should be approximately 2.5 volts positive and verifies that reference current flows through the reference divider, R25, and CR4.
- d. Repeatedly apply the 1.5 volt battery to the output connector in the same manner as in the check procedure (paragraph 4-43), and measure the transistor voltages to determine where the voltage transition stops. Start from Q1 on the Series Pass P/C Assembly and proceed toward Q7 on the Amplifier P/C Assembly.

4-48. REFERENCE NETWORK ADJUSTMENT. If the output voltage cannot be calibrated with R26 on the Amplifier P/C Assembly due to aging or changes in components, it may be necessary to adjust the reference network. Proceed as follows:

- a. First, return the network to the original configuration by soldering in jumper wires across R1, R2 and R3 on the Switch P/C Assembly. One or more of these jumpers may have been removed in the original factory calibration.
- b. Connect the differential voltmeter between the cathode of CR2 on the Amplifier P/C Assembly and chassis ground, and measure the output of the reference tube, V1. The output of the reference tube should be between 83.3 and 85.05 volts.
- c. Cut the jumper wires across R1, R2 and R3 on the Switch P/C Assembly according to the following table. Recalibrate the instrument as described in paragraph 4-29 following adjustment of the reference network.

VOLTAGE	CUT JUMPER WIRE ACROSS RESISTOR
83.20 to 83.52	NONE
83.44 to 83.70	R1
83.70 to 83.96	R2
83.94 to 84.20	R1, R2
84.20 to 84.46	R3
84.44 to 84.70	R3, R1
84.70 to 84.96	R3, R2
84.94 to 85.20	R1, R2, R3

4-49. HIGH VOLTAGE RECTIFIER. This procedure measures the output of the high voltage rectifier.

- a. Set the controls of the Model 415B as follows:

POWER	OFF
POLARITY	Negative
OUTPUT VOLTAGE dials	All zeroes
HIGH VOLTAGE	STDBY/RESET

- b. Connect the output of the Model 80F-5 Voltage Divider to the input of the differential voltmeter and connect the divider input to one of the 8068 plate clips; connect the negative lead to the top of R6 on the Bleeder P/C Assembly.

- c. Set the POWER and HIGH VOLTAGE switches to ON. Set the 500 volt OUTPUT VOLTAGE dial to each setting and measure the rectifier output. (Differential voltmeter indications are via the ten-to-one divider).

DIAL POSITION	VOLTS DC ($\pm 10\%$)
0	1700
500	2300
1000	2700
1500	3500
2500	4800

4-50. DC OUTPUT RIPPLE. This procedure measures and displays the ac ripple superimposed on the dc output.

- a. Set the controls of the Model 415B as follows:

POWER	OFF
POLARITY	Negative
OUTPUT VOLTAGE	First dial to 2500;
dials	second dial to 500;
	others to zero

- b. Connect a 0.05 microfarad, 5000 volt, capacitor and the protection circuit shown in Figure 4-2 in

series between the OUTPUT connector and the input of a preamplifier (Gain = 100). Connect the preamplifier output to the input of an oscilloscope.

- c. Set the POWER and HIGH VOLTAGE switches to ON and observe the ripple. The ripple should be less than 1.0 millivolt peak-to-peak (see Figure 4-5). (Oscilloscope display should indicate less than 100 millivolts peak-to-peak, and are typically 20 to 40 millivolts peak-to-peak).

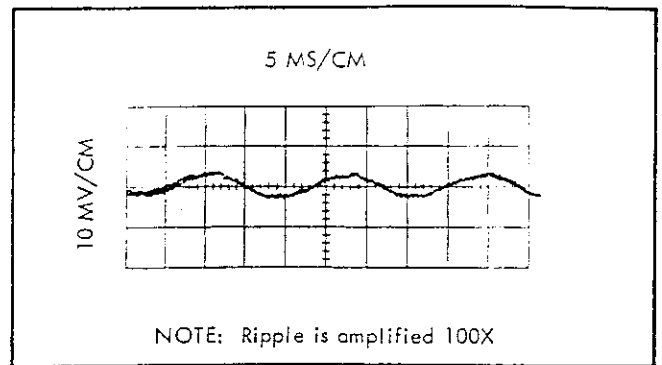

Figure 4-5. RIPPLE ON HIGH VOLTAGE DC OUTPUT

Section 5

List of Replaceable Parts

5-1. INTRODUCTION

5-2. This section contains complete descriptions of those parts one might normally expect to replace during the life of the instrument. The first listing is a breakdown of all of the major assemblies in the instrument. Subsequent listings itemize the components in each assembly. Every listing where possible, is accompanied by an illustration identifying each component in the listing. Assemblies and subassemblies are identified by a reference designation beginning with the letter A, (e.g., A1, A2, A3, etc.). Components are identified by the schematic diagram reference designation (e.g. R1, C107, DS1). Flagnotes are used throughout the parts list and refer to ordering explanations. The flag-note explanations are located at the end of the parts list section in which they appear.

5-3. COLUMNAR INFORMATION

- a. The REF DESIG column indexes the item description to the associated illustration. In general the reference designations are listed in alpha-numeric order. Subassemblies of minor proportions are sometimes listed with the assembly of which they are a part. In this case, the reference designations for the components of the subassembly may appear out of order.
- b. The DESCRIPTION column describes the salient characteristics of the component. Indention of the item description indicates the relationship to other assemblies, components, etc. In many cases it is necessary to abbreviate in this column. For abbreviations and symbols used, see Appendix B.
- c. The ten-digit part number by which the item is identified at the John Fluke Mfg. Co. is listed in the STOCK NO column. Use this number when ordering parts from the factory or authorized representatives.
- d. The Federal Supply Code for the item manufacturer is listed in the MFR column. An abbreviated list of Federal Supply Codes is included in the Appendix.
- e. The part number which uniquely identifies the item to the original manufacturer is listed in the MFR

PART NO column. If a component must be ordered by description, the type number is listed.

- f. The TOT QTY column lists the total quantity of the item used in the instrument. Second and subsequent listing of the same item are referenced to the first listing with the abbreviation REF. In the case of optional subassemblies, plug ins, etc. that are not always part of the instrument, the TOT QTY column lists the total quantity of the item in that particular assembly.
- g. Entries in the REC QTY column indicate the recommended number of spare parts necessary to support one to five instruments for a period of two years. This list presumes an availability of common electronic parts at the maintenance site. For maintenance for one year or more at an isolated site, it is recommended that at least one of every part in the instrument be stocked.
- h. The USE CODE column identifies certain parts which have been added, deleted or modified throughout the life of the instrument. Each part for which a Use Code has been assigned may be identified with a particular instrument serial number by consulting the Serial Number effectivity List, paragraph 5-7. As Use Codes are added to the list, the TOT QTY column listings are changed to reflect the most current information. Sometimes when a part is changed, the new part can and should be used as a replacement for the original part. In this event a parenthetical note is added in the DESCRIPTION column.

5-4. HOW TO OBTAIN PARTS

5-5. Standard components have been used wherever possible. Standard components may be ordered directly from the manufacturer by using the manufacturer's part number, or parts may be ordered from the John Fluke Mfg. Co. factory or authorized representative by using the Fluke stock number. In the event the part you order has been replaced by a new or improved part, the replacement will be accompanied by an explanatory note and installation instructions, if necessary.

5-6. You can insure prompt and efficient handling of

your order to the John Fluke Mfg. Co. if you include the following information:

- a. Quantity.
- b. FLUKE Stock Number.
- c. Description.
- d. Reference Designation.
- e. Instrument model and serial number.

Example: 2 each, 4805-177105, Transistors, 2N3565, Q107-108 for 845AR, s/n 168.

If you must order structural parts not listed in the parts list, describe the part as completely as possible. A sketch of the part showing its location to other parts of the instrument is usually most helpful.

5-7. SERIAL NUMBER EFFECTIVITY

5-8. A Use Code column is provided to identify certain parts that have been added, deleted, or modified during production of the Model 415B. Each part for which a use code has been assigned may be identified with a particular instrument serial number by consulting the Use Code Effectivity List below. All parts with no code

are used on all instruments with serial numbers above 123. New codes will be added as required by instrument changes.

USE CODE	EFFECTIVITY
No Code	Model 415A serial number 123 thru 487. Model 415B serial number 488 and on.
A	Model 415B serial number 488 thru 688, 691 thru 693, 696, 697, 699 thru 713, 715 and 716.
B	Model 415B serial number 689, 690, 694, 695, 698, 714, 717 and on.
C	Model 415B serial number 689, 690, 694, 695, 698, 714, 717 thru 1779.
D	Model 415B serial number 1780 and on.
E	Model 415B serial number 123 thru 2029
F	Model 415B serial number 2030 thru 90099
G	Model 415B serial number 90100 and on

REF DESIG	DESCRIPTION	STOCK NO	MFR	MFR PART NO	TOT QTY	REC QTY	USE CODE
	HIGH VOLTAGE POWER SUPPLY Figure 5-1						
	MODEL 415A - Serial Number 123 through 487.						
	MODEL 415B - Serial Number 488 and on.						
A1	Chassis Assembly (See Figure 5-2)						
A2	Front Panel Assembly (See Figure 5-3)						
A3	Switch P/C Assembly (See Figure 5-4)	1702-219873 (415A-4001)	89536	1702-219873	1		
A4	High Voltage Rectifier P/C Assembly (See Figure 5-5)	1702-219881 (415A-4002)	89536	1702-219881	1		
A5	Series Pass P/C Assembly (See Figure 5-6)	1702-219899 (415A-4003)	89536	1702-219899	1		
A6	Amplifier P/C Assembly (See Figure 5-7)	1702-219907 (415A-4004)	89536	1702-219907	1		
A7	Bleeder P/C Assembly (See Figure 5-8)	1702-219915 (415A-4005)	89536	1702-219915	1		
1	Connector, Type BNC (accessory) (not illustrated)	2106-100735	95712	486-2	1		

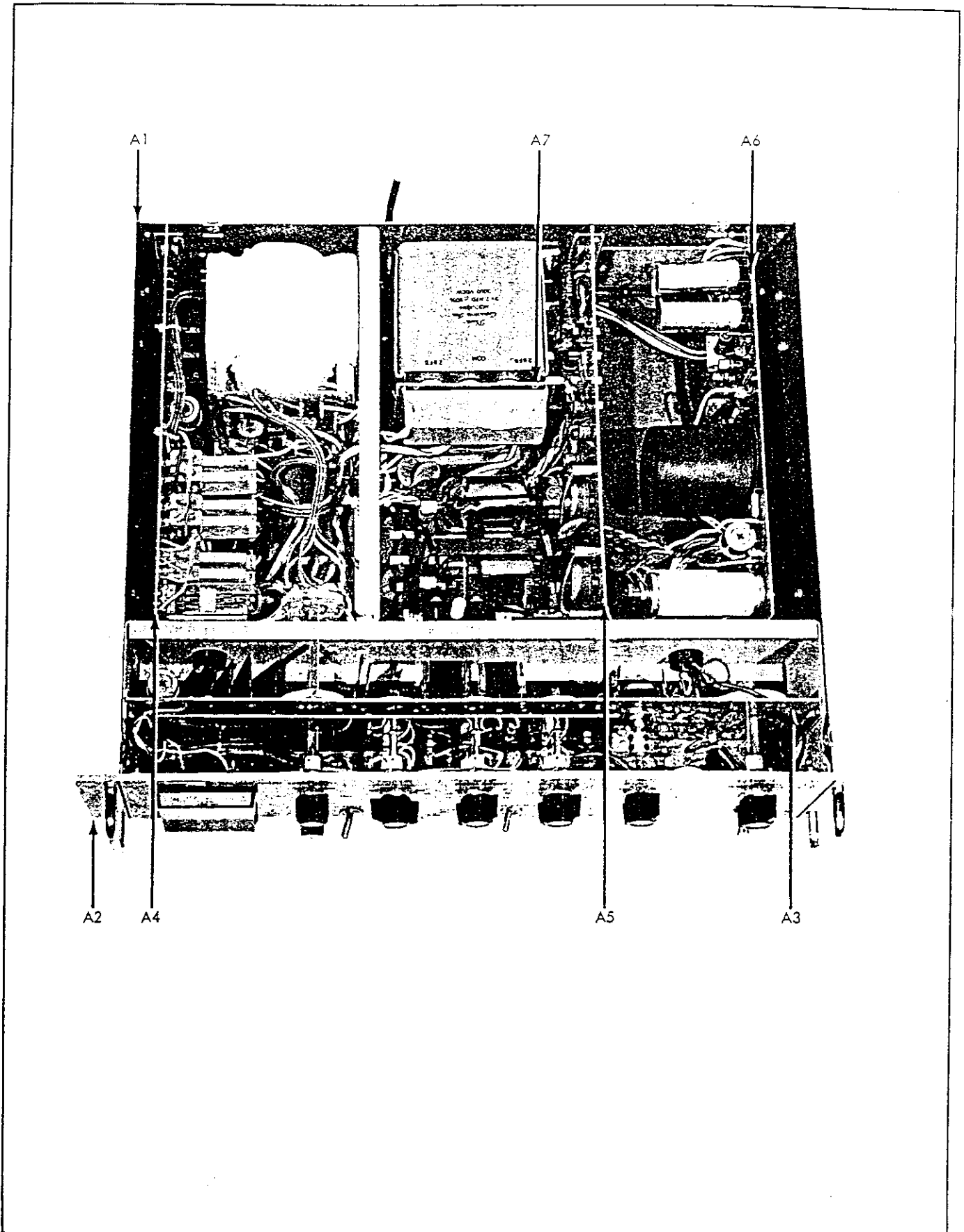

Figure 5-1. HIGH VOLTAGE POWER SUPPLY

REF DESIG	DESCRIPTION	STOCK NO	MFR	MFR PART NO	TOT QTY	REC QTY	USE CODE
A1	CHASSIS ASSEMBLY - Figure 5-2						
C1	Cap, cer, 0.01 uf, gmV, 1,600v	1501-106930	71590	DD16-103	3	1	
C2	Cap, cer, 0.01 uf, gmV, 1,600v	1501-106930	71590	DD16-103	REF		
C3	Cap, cer, 0.005 uf $\pm 20\%$, 3,000v	1501-188003	71590	DD30-502	4		
C4	Cap, cer, 0.005 uf $\pm 20\%$, 3,000v	1501-188003	71590	DD30-502	REF		
C5	Cap, cer, 0.005 uf $\pm 20\%$, 3,000v	1501-188003	71590	DD30-502	REF		
C6	Cap, cer, 0.005 uf $\pm 20\%$, 3,000v	1501-188003	71590	DD30-502	REF		
C7, C8	Cap, oil, 2 x 2 uf $\pm 20\%$, 3,000v	1505-195578	56289	P-158039	1		
J2	Connector, female, Type BNC	2106-162982	95712	3651-2	2		
P1	Line cord	6005-102822	89536	6005-102822	1		
S3A	Switch wafer, OUTPUT VOLTAGE	5107-167817	76854	Type HC	1		
S8	Switch, interlock, spdt	5104-115196	01963	E13-00A	1		
T1	Transformer, power (115/230V)	5602-217786	89536	5602-217786	1		
T1	Transformer, power (100/115V)	5602-350330	89536	5602-350330	1		
2	Coupler, A3R23	2402-104505	89536	2402-104505	1		
3	Cover, top (not illustrated)	1403-169557	89536	1403-169557	1		
4	Detent assembly, switch S3	5108-216952	76854	Type H	1		
5	Detent assembly, switch S4	5108-155952	76854	239913-H	1		
6	Detent assembly, switch S5 & S6	5108-155945	76854	239914-H	2		
7	Detent assembly, switch S7	5108-155960	76854	239912-H	1		
8	Foot, rubber (not illustrated)	2819-103309	77969	9102-W	4		
9	Plate, switch locating (between detents and front panel)	3156-169524	89536	3156-169524	1		
10	Shaft, A3R23	3103-156349	89536	3103-156349	1		

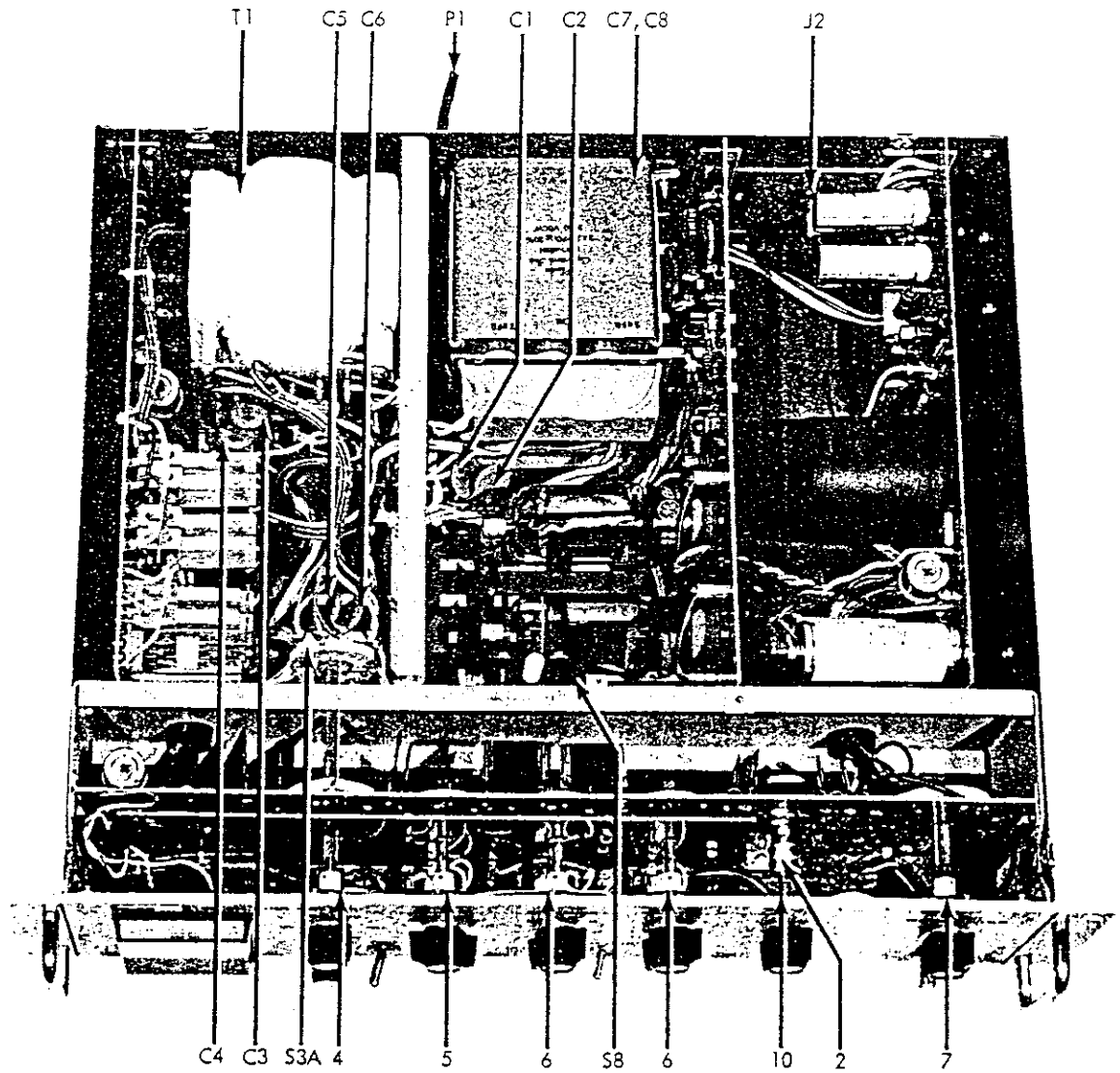

Figure 5-2. CHASSIS ASSEMBLY

REF DESIG	DESCRIPTION	STOCK NO	MFR	MFR PART NO	TOT QTY	REC QTY	USE CODE
A2	FRONT PANEL ASSEMBLY Figure 5-3						
DS1	Lamp, neon, NE51, red lens	3903-100206	91802	1040A1	2		
DS2	Lamp, neon, NE51, white lens	3903-100214	91802	1040A4	1		
DS3	Lamp, neon, NE51, red lens	3903-100206	91802	1040A1	REF		
F1	Fuse, slow blow, 3 amp, 250v (for 115v operation) (not illustrated)	5101-109280	71400	Type MDA	1	1	
F1	Fuse, slow blow, 1-1/2 amp, 250v (for 230v operation) (not illustrated)	5101-109231	71400	Type MDX	1	1	
J1	Connector, female, Type BNC	2106-162982	95712	3651-2	REF		
M1	Meter, 500-0-500 ua, 50Ω	2901-221721	89536	2901-221721	1		
S1	Switch, POWER, toggle, dpst	5106-114835	04009	81024-GB	1		
S2	Switch, HIGH VOLTAGE, toggle, dpdt	5106-157883	73559	2GL50-63	1		
XF1	Holder, fuse	2102-100107	71400	HKP	1		
11	Handle, chrome-plated brass	2404-100412	05704	825	2		
12	Knob, bar	2405-170050	89536	2405-170050	6		
13	Panel, front	1406-220095	89536	1406-220095	1		

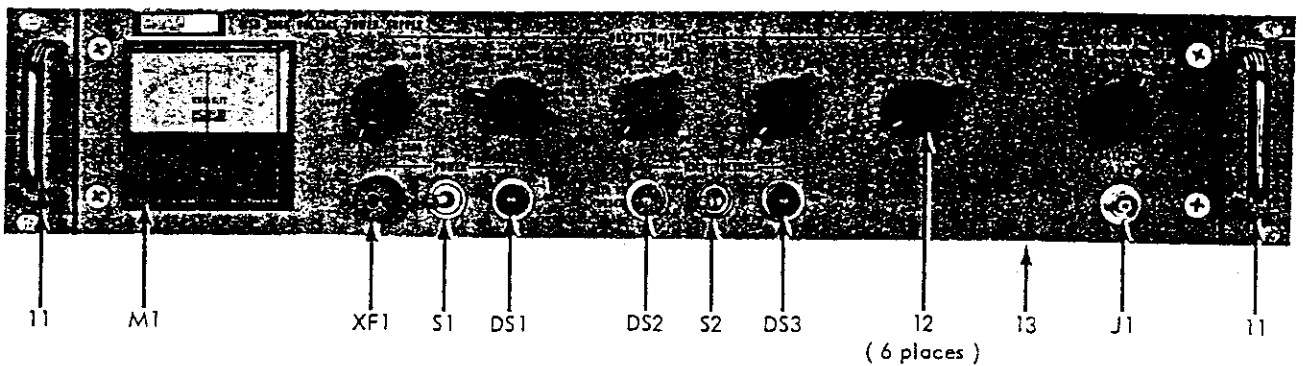

Figure 5-3. FRONT PANEL ASSEMBLY

REF DESIG	DESCRIPTION	STOCK NO	MFR	MFR PART NO	TOT QTY	REC QTY	USE CODE
A3	SWITCH P/C ASSEMBLY - Figure 5-4	1702-219873 (415A-4001)	89536	1702-219873	REF		
R1	Res, ww, 120Ω ±0.1%, 1/2w	4707-232371	89536	4707-232371	1		
R2	Res, ww, 250Ω ±0.1%, 1/2w	4707-199893	89536	4707-199893	1		
R3	Res, ww, 500Ω ±0.1%, 1/2w	4707-232405	89536	4707-232405	1		
R4	Res, ww, 41.6k ±0.05%, 1-1/2w	4707-199778	89536	4707-199778	1	1	
R5	Res, ww, 250k ±0.05%, 2w	4707-238337	89536	4707-238337	5	2	
R6	Res, ww, 250k ±0.05%, 2w	4707-238337	89536	4707-238337	REF		
R7	Res, ww, 250k ±0.05%, 2w	4707-238337	89536	4707-238337	REF		
R8	Res, ww, 250k ±0.05%, 2w	4707-238337	89536	4707-238337	REF		
R9	Res, ww, 250k ±0.05%, 2w	4707-238337	89536	4707-238337	REF		
R10	Res, ww, 100k ±0.1%, 1w	4707-142349	89536	4707-142349	2	1	
R11	Res, ww, 100k ±0.1%, 1w	4707-142349	89536	4707-142349	REF		
R12	Res, ww, 50k ±0.1%, 1w	4707-156455	89536	4707-156455	1	1	
R13	Res, ww, 10k ±0.1%, 1w	4707-131664	89536	4707-131664	4	2	
R14	Res, ww, 10k ±0.1%, 1w	4707-131664	89536	4707-131664	REF		
R15	Res, ww, 10k ±0.1%, 1w	4707-131664	89536	4707-131664	REF		
R16	Res, ww, 10k ±0.1%, 1w	4707-131664	89536	4707-131664	REF		
R17	Res, ww, 5k ±0.1%, 1w	4707-149708	89536	4707-149708	1	1	
R18	Res, met flm, 1k ±1%, 1/2w	4705-151324	75042	Type CEC-TO	6	3	
R19	Res, met flm, 1k ±1%, 1/2w	4705-151324	75042	Type CEC-TO	REF		
R20	Res, met flm, 1k ±1%, 1/2w	4705-151324	75042	Type CEC-TO	REF		
R21	Res, met flm, 1k ±1%, 1/2w	4705-151324	75042	Type CEC-TO	REF		
R22	Res, met flm, 499Ω ±1%, 1/2w	4705-151514	75042	Type CEC-TO	1	1	
R23	Res, var, ww, 600Ω ±10%, 2w	4702-155523	71450	Type 252	1		
R24	Res, met flm, 2.67M ±1%, 2w	4705-169391	00327	Type M14	2		
R25	Res, met flm, 2.67M ±1%, 2w	4705-169391	00327	Type M14	REF		
R26	Res, var, ww, 500Ω ±10%, 1-1/4w	4702-113258	71450	Type 110	1		
R27	Res, met flm, 300Ω ±1%, 1/2w <i>100Ω jmx</i>	4705-172130 4705-151480	75042	Type CEC-TO	1		
S3B	Switch section, OUTPUT VOLTAGE	5107-167809	76854	247490-HC	1		
S4	Switch section, OUTPUT VOLTAGE	5107-155978	76854	244993-FC	3		

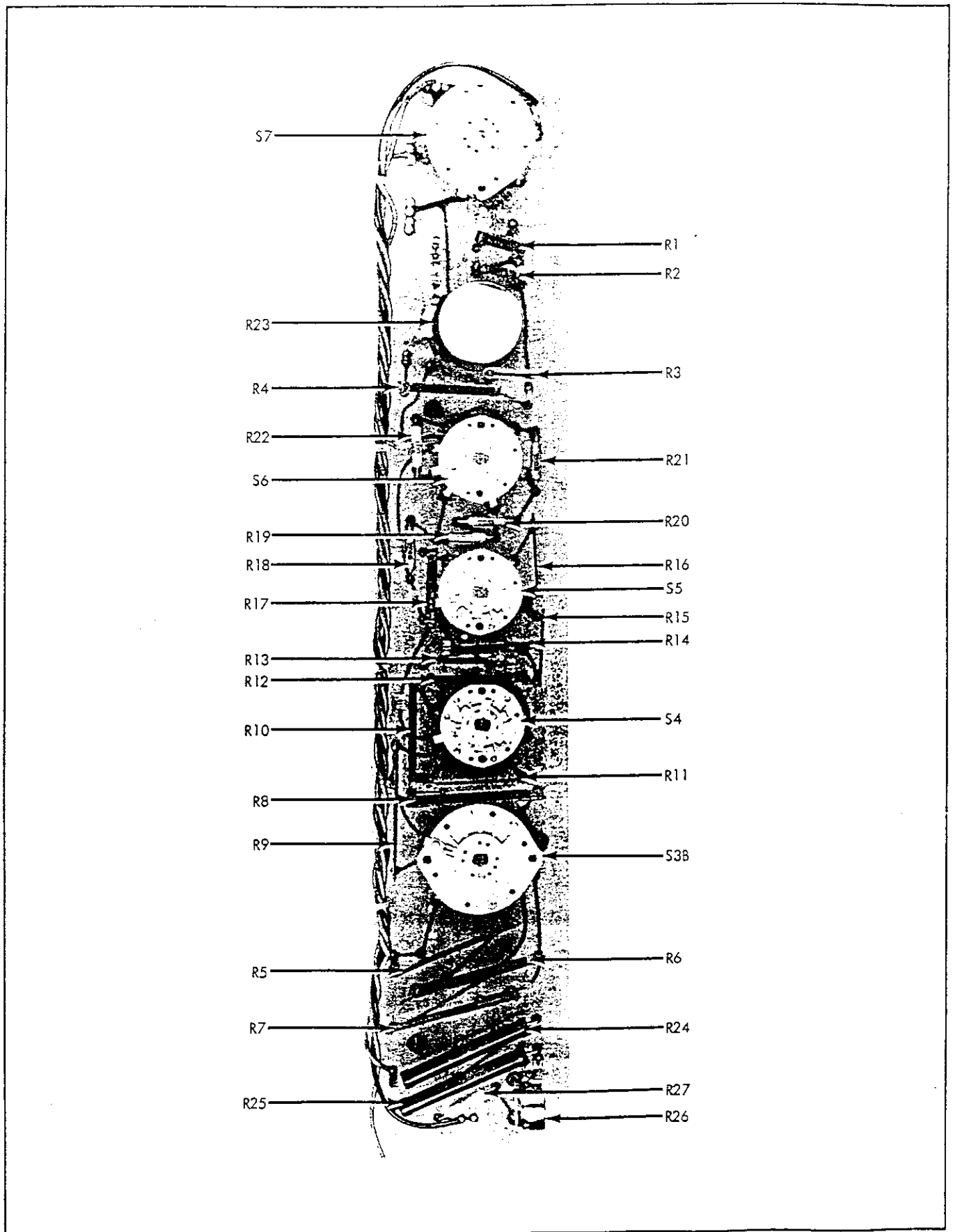





Figure 5-4. SWITCH P/C ASSEMBLY

REF DESIG	DESCRIPTION	STOCK NO	MFR	MFR PART NO	TOT QTY	REC QTY	USE CODE
S5	Switch section, OUTPUT VOLTAGE	5107-155978	76854	244993-FC	REF		
S6	Switch section, OUTPUT VOLTAGE	5107-155978	76854	244993-FC	REF		
S7	Switch section, POLARITY	5107-155929	76854	239955-HC	1		

REF DESIG	DESCRIPTION	STOCK NO	MFR	MFR PART NO	TOT QTY	REC QTY	USE CODE
A4	HIGH VOLTAGE RECTIFIER P/C ASSEMBLY- Figure 5-5	1702-219881 (415A-4002)	89536	1702-219881	REF		
C1	Cap, elect, 40 uf +100/-10%, 250v	1502-202929	76149	PFP20-35561	3	1	
C2	Cap, elect, 10 uf +75/-10%, 150v	1502-106351	56289	30D106G150DF4	1		
CR1	Diode, silicon, 1 amp, 600 piv	4802-112383	05277	1N4822	27	22	
CR2 thru CR23	Diode, silicon, 1 amp, 600 piv 	4802-112383	05277	1N4822	REF		
CR2 thru CR5	Diode, silicon, 250 ma, 4000 piv 	4802-268342	04713	MR995A	4		
K1	Relay, 115V, spst, 20 sec time delay	4502-245324	70563	115N020T	1		
K2	Relay, armature, dpdt, 230 vac	4504-221234	89536	4504-221234	1		
K3	Relay, armature, dpdt, 230 vac	4504-220111	89536	4504-220111	2	2	
K4	Relay, armature, dpdt, 230 vac	4504-220111	89536	4504-220111	REF		
R1	Res, comp, 68k ±10%, 1w	4704-109629	01121	GB6831	1		
R2	Res, comp, 390Ω ±10%, 2w	4704-110049	01121	HB3911	1		
R3	Res, comp, 10Ω ±10%, 1/2w	4704-108092	01121	EB1001	2		
R4	Res, comp, 100Ω ±10%, 2w	4704-109934	01121	HB1011	1		
R5	Res, var, ww, 1k ±20%, 1-1/4w	4702-113266	71450	Type 110	1		E
R5	Res, var, ww, 150Ω ±10%, 1-1/4 w	4702-113092	71450	Type 110	2		F
R6	Res, comp, 47Ω ±10%, 1/2w	4704-108688	01121	EB4701	1		E
R6	Res, comp, 68Ω ±10%, 1/2w	4704-178384	01121	EB6801	1		F
R6	Deleted 39Ω	4704-160036		EB3901 Jim			G

 On some instruments, CR2 thru CR23 is replaced with four diodes, CR2 thru CR5. When ordering, determine the appropriate part number for the particular instrument.

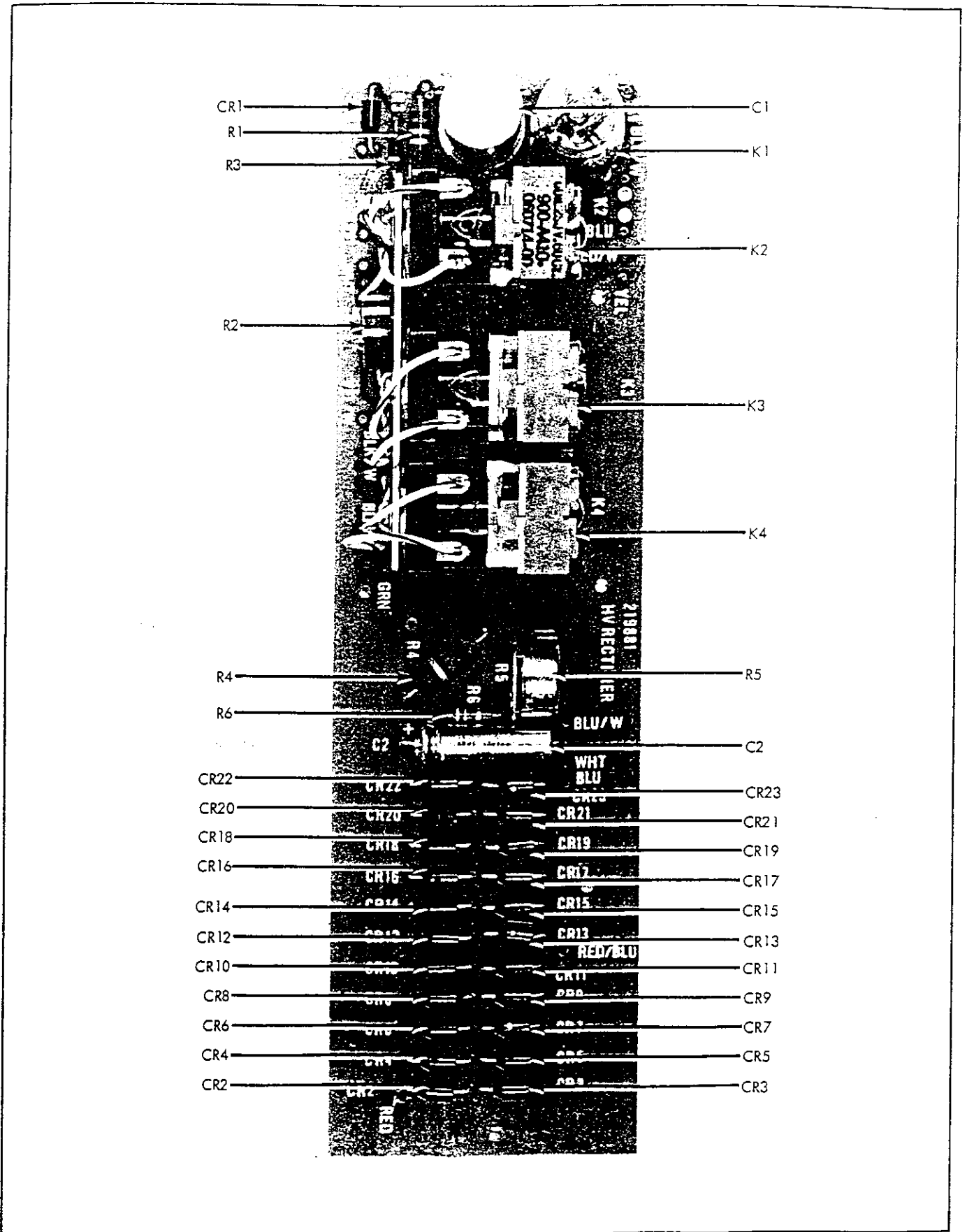

Figure 5-5. HIGH VOLTAGE RECTIFIER P/C ASSEMBLY

REF DESIG	DESCRIPTION	STOCK NO	MFR	MFR PART NO	TOT QTY	REC QTY	USE CODE
A5	SERIES PASS P/C ASSEMBLY Figure 5-6	1702-219899 (415A-4003)	89536	1702-219899	REF		
C1	Cap, cer, 0.02 uf $\pm 20\%$, 1,000v	1501-217810	56289	41C301A2	1	1	
C2	Cap, elect, 200 uf $-75/-10\%$, 12v	1502-150284	56289	30D207G012DF4	1	1	
C3	Cap, cer, 0.1 uf $-80/-20\%$, 500v	1501-105684	56289	41C92	5	2	
C4	Cap, cer, 0.1 uf $+80/-20\%$, 500v	1501-105684	56289	41C92	REF		
C5	Cap, cer, 0.1 uf $-80/-20\%$, 500v	1501-105684	56289	41C92	REF		
C6	Cap, cer, 180 pf $\pm 10\%$, 1000v FACTORY SELECTED	1501-105890	71590	BB50181KS3N	1		<i>jmz</i>
CR1	Diode, silicon, 1 amp, 600 piv	4802-112383	05277	1N4822	REF		
CR2	Diode, silicon, 1 amp, 600 piv	4802-112383	05277	1N4822	REF		
CR3	Diode, zener, 75v	4803-168096	04713	1N3041A	1	1	
CR4	Diode, zener, 10v	4803-113324	07910	1N961A	2	1	
CR5	Diode, zener, 10v	4803-113324	07910	1N961A	REF		
CR6	Diode, zener, 110v	4803-168104	04713	1N3045A	1	1	
Q1	Tstr, silicon, PNP	4805-218388	07263	2N3645	3	2	
Q2	Tstr, silicon, PNP	4805-218388	07263	2N3645	REF		
Q3	Tstr, silicon, PNP	4805-218388	07263	2N3645	REF		
Q4	Tstr, silicon, NPN Tstr, silicon, NPN XSTR, Si, NPN	4805-203489 4805-168716 203489	07010 07263 89536	CDQ10656 S19254 203489	4 1 1		A B
R1	Res, comp, $22\Omega \pm 10\%$, 1/2w	4704-108670	01121	EB2201	1		
R2	Res, comp, $10\Omega \pm 10\%$, 1/2w	4704-108092	01121	EB1001	REF		
R3	Res, ww, $30k \pm 5\%$, 10w	4706-155432	06136	Type 10F	2		
R4	Res, ww, $30k \pm 5\%$, 10w	4706-155432	06136	Type 10F	REF		
R5	Res, comp, $150k \pm 10\%$, 2w	4704-109959	01121	HB1541	1		
R6	Res, comp, $10k \pm 10\%$, 1/2w	4704-108118	01121	EB1031	2		
R7	Res, comp, $68k \pm 10\%$, 2w	4704-110114	01121	HB6831	1		
R8	Res, comp, $1k \pm 10\%$, 1/2w	4704-108563	01121	EB1021	2		
R9	Res, comp, $100\Omega \pm 10\%$, 1/2w	4704-108100	01121	EB1011	2		
R10	Res, comp, $10k \pm 10\%$, 1/2w	4704-108118	01121	EB1031	REF		
R11	Res, comp, $1k \pm 10\%$, 1/2w	4704-108563	01121	EB1021	REF		
R12	Res, comp, $100\Omega \pm 10\%$, 1/2w	4704-108100	01121	EB1011	REF		

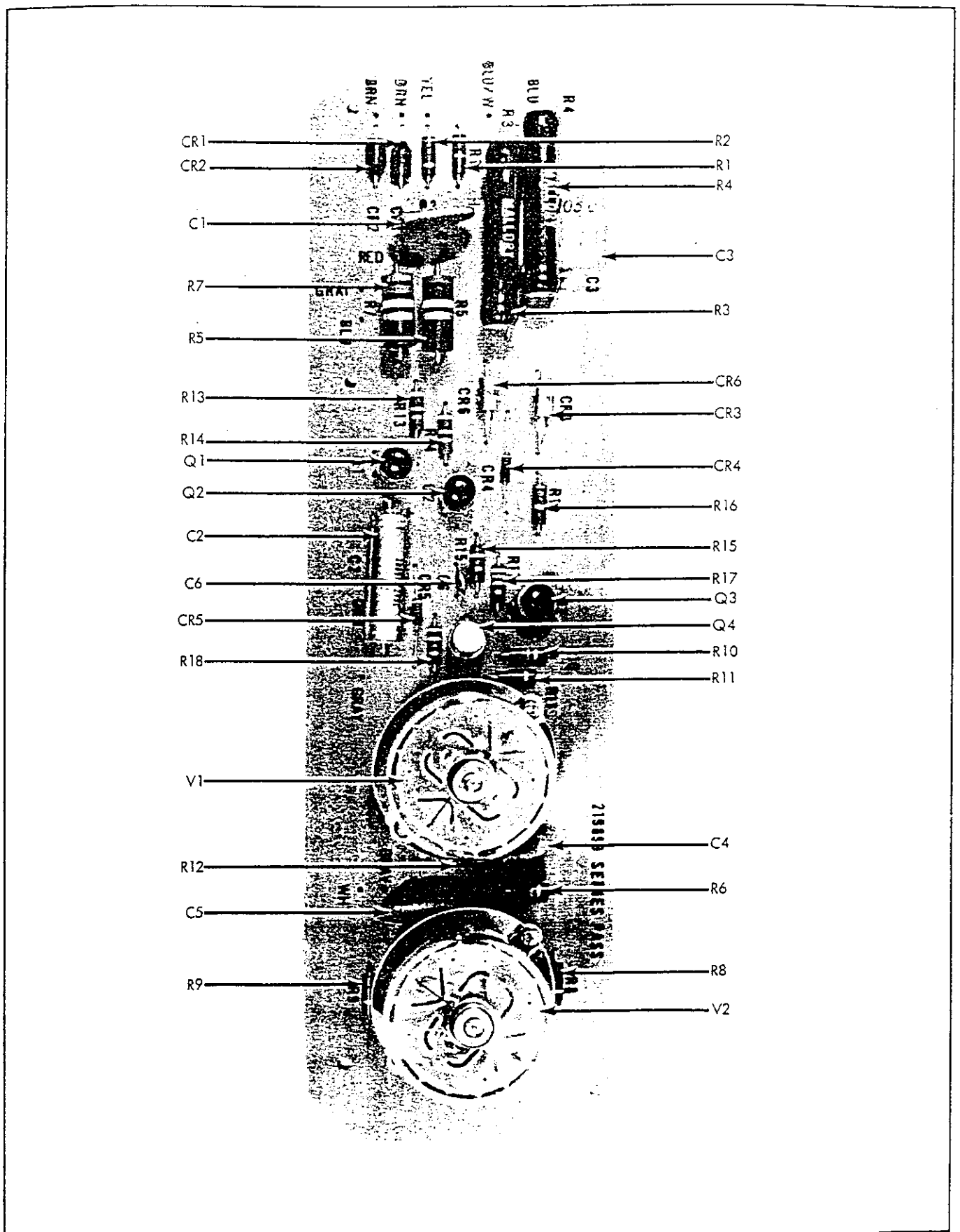

Figure 5-6. SERIES PASS P/C ASSEMBLY

REF DESIG	DESCRIPTION	STOCK NO	MFR	MFR PART NO	TOT QTY	REC QTY	USE CODE
R13	Res, comp, 47k \pm 5%, 1/2w	4704-108738	01121	EB4735	3		
R14	Res, comp, 47k \pm 5%, 1/2w	4704-108738	01121	EB4735	REF		
R15	Res, comp, 270 Ω \pm 5%, 1/2w	4704-159616	01121	EB2715	1		
R16	Res, comp, 680 Ω \pm 10%, 1/2w	4704-108712	01121	EB6811	1		
R17	Res, comp, 47k \pm 5%, 1/2w	4704-108738	01121	EB4735	REF		
R18	Res, comp, 4.7k \pm 10%, 1/2w	4704-108381	01121	EB4721	2		
V1	Tube, tested type 8068	5701-156422	89536	5701-156422	2	2	
V2	Tube, tested type 8068	5701-156422	89536	5701-156422	REF		



Use part number 4805-168716 as Q4 replacement for all serial numbers.

REF DESIG	DESCRIPTION	STOCK NO	MFR	MFR PART NO	TOT QTY	REC QTY	USE CODE
A6	AMPLIFIER P/C ASSEMBLY Figure 5-7	1702-219907 (415A-4004)	89536	1702-219907	REF		
C1	Cap, elect, 40 uf +100/-10%, 250v	1502-202929	76149	PFP20-35561	REF		
C2	Cap, elect, 40 uf +100/-10%, 250v	1502-202929	76149	PFP20-35561	REF		
C3	Cap, plstc, 2 uf ±20%, 200v	1507-106443	72928	364-060M	1		
C4	Cap, cer, 0.1 uf +80/-20%, 500v	1501-105684	56289	41C92	REF		
C5	Cap, cer, 0.0027 uf, gm, 600v	1501-106211	72982	851-000-Z5UO- 272P	1	1	
C6	Cap, cer, 0.05 uf +80/-20%, 500v	1501-105676	56289	33C58B	1		
C7	Cap, cer, 0.0012 uf ±10%, 500v	1501-106732	71590	CF-122	1	1	
C8	Cap, cer, 300 pf ±10%, 500v	1501-105734	71590	BB60301KW7W	1	1	
C9	Cap, cer, 0.1 uf +80/-20%, 500v	1501-105684	56289	41C92	REF		
C10	Cap, cer, 0.01 uf, gm, 1,600v	1501-106930	71590	DD16-103	REF		
C11	Cap, oil, 0.25 uf ±10%, 3,000v	1505-104836	01884	SMLE254-3M	2	1	
C12	Cap, oil, 0.25 uf ±10%, 3,000v	1505-104836	01884	SMLE254-3M	1		
CR1	Diode, zener, 12v	4803-159780	07910	1N759	1		
CR2	Diode, silicon, 1 amp, 100 piv	4802-116111	05277	1N4817	2	2	
CR3	Diode, silicon, 1 amp, 100 piv	4802-116111	05277	1N4817	REF		
CR4	Diode, silicon, 1 amp, 600 piv	4802-112383	05277	1N4822	REF		
CR5	Diode, silicon, 1 amp, 600 piv	4802-112383	05277	1N4822	REF		
DS1	Lamp, neon, Type NE2E	3902-100347	71744	NE2E	2	2	
DS2	Lamp, neon, Type NE2E	3902-100347	71744	NE2E	REF		
Q1	Tstr, silicon, NPN	4805-190710	04713	2N3739	1	1	
Q2	Tstr, silicon, NPN	4805-203489	07910	CDQ10356	1		
Q3	Tstr, silicon, NPN	4805-203489	07910	CDQ10656	REF		A
	Tstr, silicon, NPN	4805-168716	07263	S19254	REF		C
	Tstr, silicon, NPN	4805-269084	07910	CS2484	2		D
Q4, Q5	Tstr, selected, silicon, NPN	4805-235812	89536	4805-235812	2		A
	Tstr, selected, silicon, NPN	4805-265173	89536	4805-265173	2	2	B
Q6	Tstr, silicon, NPN	4805-203489	07910	CDQ10656	REF		A
	Tstr, silicon, NPN	4805-168716	07263	S19254	REF		C
	Tstr, silicon, NPN	4805-269084	07910	CS2484	REF		D
Q7, Q8	Tstr, selected, silicon, NPN	4805-235812	89536	4805-235812	REF		A
	Tstr, selected, silicon, NPN	4805-265173	89536	4805-265173	REF		B
R1	Res, comp, 360Ω ±5%, 2w	4704-178582	01121	HB3615	1	1	
R2	Res, comp, 8.2k ±10%, 2w	4704-110072	01121	HB8221	1	1	

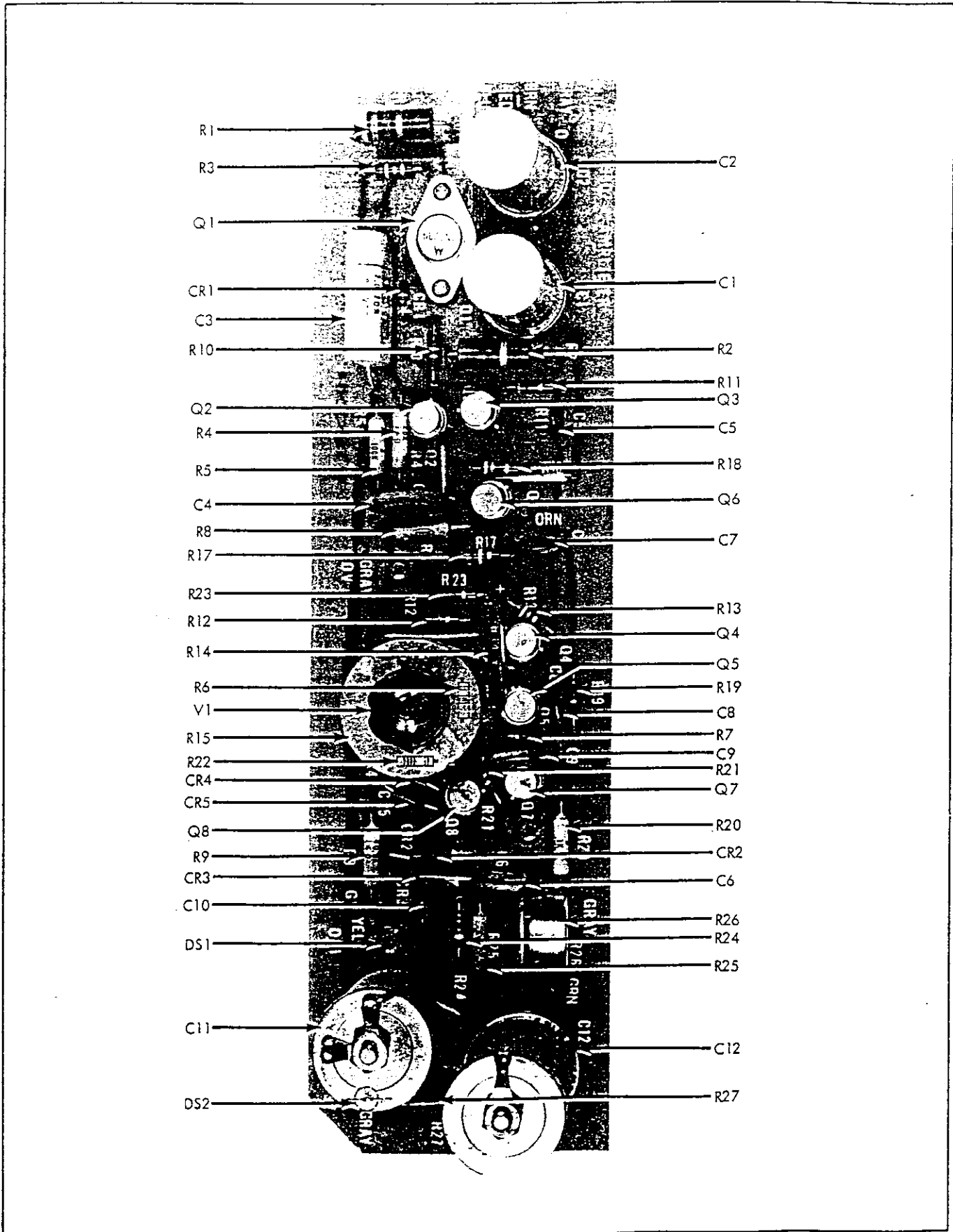





Figure 5-7. AMPLIFIER P/C ASSEMBLY

REF DESIG	DESCRIPTION	STOCK NO	MFR	MFR PART NO	TOT QTY	REC QTY	USE CODE
R3	Res, comp, 2.7 Ω \pm 10%, 1/2w	4704-108845	01121	EB27G1	1		
R4	Res, met flm, 20k \pm 1%, 1/2w	4705-162438	75042	Type CEC-TO	1		
R5	Res, met flm, 100k \pm 1%, 1/2w	4705-151316	75042	Type CEC-TO	1		
R6	Res, comp, 47k \pm 10%, 1/2w	4704-108480	01121	EB4731	1		
R7	Res, comp, 2.7k \pm 10%, 1/2w	4704-108837	01121	EB2721	1		
R8	Res, met flm, 40.2k \pm 1%, 1/2w	4705-161059	75042	Type CEC-TO	1		
R9	Res, met flm, 80.6k \pm 1%, 1/2w	4705-150680	75042	Type CEC-TO	1		
R10	Res, comp, 15k \pm 10%, 1/2w	4704-108530	01121	EB1531	1		
R11	Res, comp, 300 Ω \pm 5%, 1/2w	4704-108829	01121	EB3015	1		
R12	Res, comp, 82k \pm 10%, 1/2w	4704-108498	01121	EB8231	1		
R13	Res, comp, 39k \pm 10%, 1/2w	4704-108555	01121	EB3931	1		
R14	Res, ww, factory selected and matched				1	1	
R15	Res, ww, factory selected and matched				1	1	
R17	Res, comp, 100k \pm 10%, 1/2w	4704-108126	01121	EB1041	1		
R18	Res, comp, 4.7k \pm 10%, 1/2w	4704-108381	01121	EB4721	REF		
R19	Res, comp, 1k \pm 5%, 1/2w	4704-108597	01121	EB1025	1		
R20	Res, met flm, 1k \pm 1%, 1/2w	4705-151324	75042	Type CEC-TO	REF		
R21	Res, comp, 270k \pm 10%, 1/2w	4704-108258	01121	EB2741	2		
R22	Res, comp, 270k \pm 10%, 1/2w	4704-108258	01121	EB2741	REF		
R23	Res, comp, 1.2M \pm 10%, 1/2w	4704-108407	01121	EB1251	1		
R24	Res, comp, 2.2k \pm 10%, 1/2w	4704-108605	01121	EB2221	1		
R25	Res, met flm, 1k \pm 1%, 1/2w	4705-151324	75042	Type CEC-TO	REF		
R26	Res, var, ww, 150 Ω \pm 10%, 1-1/4w	4702-113092	71450	Type 110	REF		
R27	Res, comp, 1.3 Ω \pm 5%, 1/2w	4704-218719	01121	EB13G5	1		
V1 *	Tube, factory aged and selected Type 83A1					1	
14	Cover (not illustrated)	3155-156778	89536	3155-156778	1		



Use part number 4805-168716 as Q3 replacement on serial numbers 123 thru 1779.



Q4/Q5, and Q7/Q8 are factory selected and paired. For replacement, it is necessary to replace them in pairs. Use part number 4805-265173 as replacement on all serial numbers.



R14, R15 and V1 are a factory matched set according to aging and selection of V1. If replacement is necessary, order part number 3158-239707 or 3158-239715. These two sets are completely interchangeable, however, the individual components must not be separated.

* for replacement substitute PCB, 451047, 89536, 451047 JML

REF DESIG	DESCRIPTION	STOCK NO	MFR	MFR PART NO	TOT QTY	REC QTY	USE CODE
A7	BLEEDER P/C ASSEMBLY - Figure 5-8	1702-219915 (415A-4005)	89536	1702-219915	REF		
K1	Relay, reed, spst, 250v	4501-169698	89536	4501-169698	1	1	
R1	Res, comp, 2.2M \pm 10%, 2w	4704-167304	01121	HB2251	6		
R2	Res, comp, 2.2M \pm 10%, 2w	4704-167304	01121	HB2251	REF		
R3	Res, comp, 2.2M \pm 10%, 2w	4704-167304	01121	HB2251	REF		
R4	Res, comp, 2.2M \pm 10%, 2w	4704-167304	01121	HB2251	REF		
R5	Res, comp, 2.2M \pm 10%, 2w	4704-167304	01121	HB2251	REF		
R6	Res, comp, 2.2M \pm 10%, 2w	4704-167304	01121	HB2251	REF		
R7	Res, comp, 68 \pm 5%, 1/2w	4704-178384	01121	HB6805	1		H
15	Wire assembly, Series Pass tube	6008-219980	89536	6008-219980	2		
R7	RES, COMP, 47 \pm 5%, 1/2 W 9111Z	4704-159608	01121	HB4705	1		G

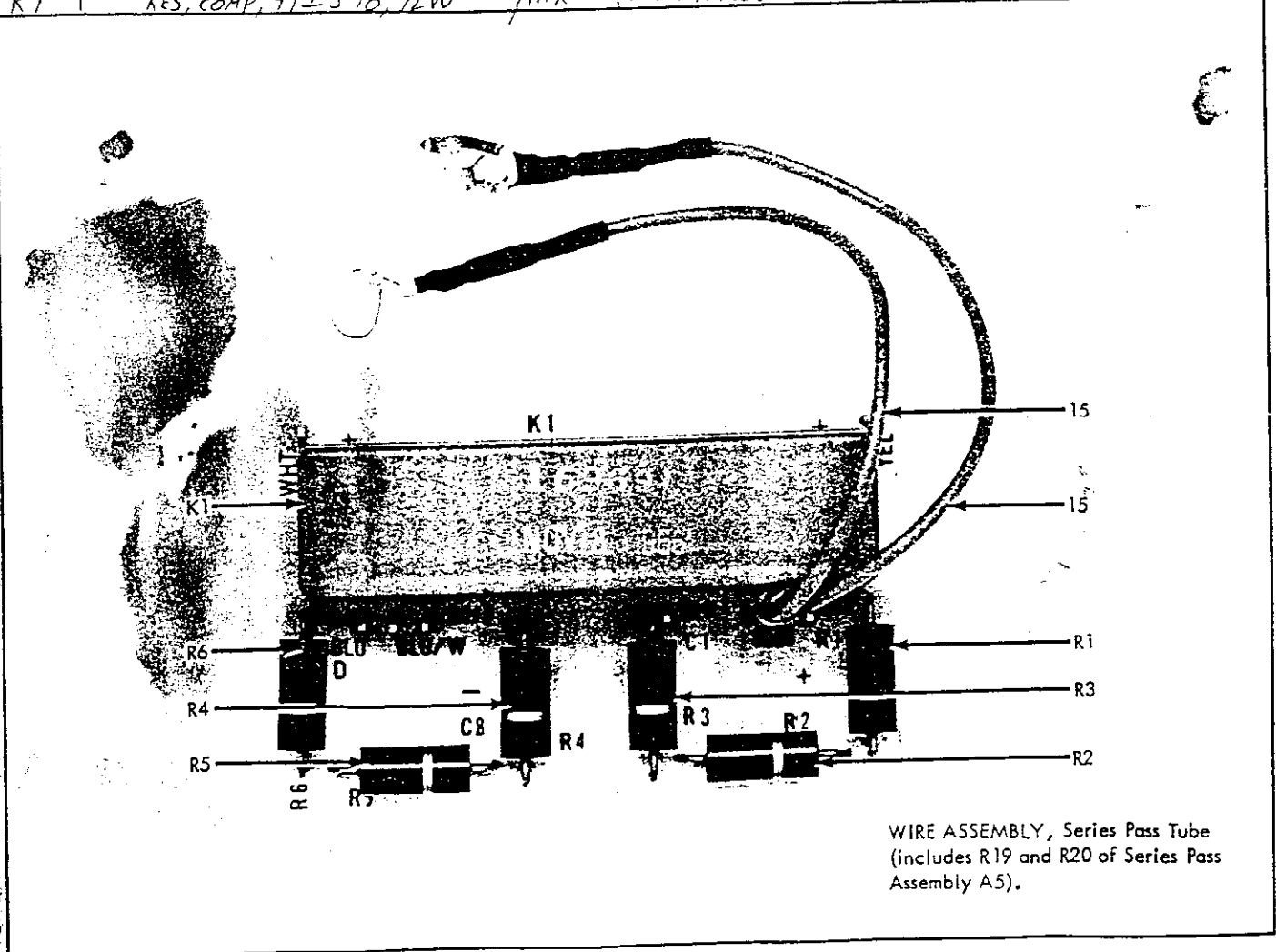

Figure 5-8. BLEEDER P/C ASSEMBLY

